



# Environment Monitoring Sensor

## Featuring LoRaWAN<sup>®</sup>

### EM300 Series

User Guide



## Applicability

This guide is applicable to EM300 series sensors shown as follows, except where otherwise indicated.

Model	Description
EM300-TH	Temperature and Humidity Sensor
EM300-MCS	Magnet Switch Sensor
EM300-SLD	Spot Leak Detection Sensor
EM300-ZLD	Zone Leak Detection Sensor
EM300-MLD	Membrane Leak Detection Sensor
EM300-DI	Pulse Counter Sensor
EM300-CL	Capacitive Level Sensor

## Safety Precautions

Milesight will not shoulder responsibility for any loss or damage resulting from not following the instructions of this operating guide.

- ❖ The device must not be disassembled or remodeled in any way.
- ❖ In order to protect the security of the device, please change device password when first configuration. The default password is 123456.
- ❖ The device is not intended to be used as a reference sensor, and Milesight will not should responsibility for any damage which may result from inaccurate readings.
- ❖ Do not place the device close to objects with naked flames.
- ❖ Do not place the device where the temperature is below/above the operating range.
- ❖ Make sure electronic components do not drop out of the enclosure while opening.
- ❖ When installing the battery, please install it accurately, and do not install the reverse or wrong model.
- ❖ Make sure both batteries are newest when install, or battery life will be reduced.
- ❖ The device must never be subjected to shocks or impacts.

## Declaration of Conformity

EM300 series is in conformity with the essential requirements and other relevant provisions of the CE, FCC, and RoHS.

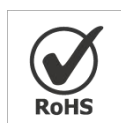

Copyright © 2011-2023 Milesight. All rights reserved.

All information in this guide is protected by copyright law. Whereby, no organization or individual shall copy or reproduce the whole or part of this user guide by any means without written authorization from Xiamen Milesight IoT Co., Ltd.



For assistance, please contact

Milesight technical support:

Email: [iot.support@milesight.com](mailto:iot.support@milesight.com)

Support Portal: [support.milesight-iot.com](http://support.milesight-iot.com)

Tel: 86-592-5085280

Fax: 86-592-5023065

Address: Building C09, Software Park III,  
Xiamen 361024, China

## Revision History

Date	Doc Version	Description
Oct. 14, 2020	V 1.0	Initial version
Oct. 21, 2020	V 1.1	Model name change and pictures replace
Nov. 19, 2020	V 2.0	Layout replace
Mar. 4, 2021	V 2.1	Layout update
July 5, 2021	V 2.2	Delete USB Type-C description
Dec. 7, 2021	V 2.3	Add alarm setting, change SN to 16 digits
Nov. 24, 2022	V 2.4	<ol style="list-style-type: none"> <li>1. Add EM300-DI model</li> <li>2. Add Milesight D2D feature</li> <li>3. Add data storage and retransmission feature</li> <li>4. Add time synchronization feature</li> </ol>
Oct. 31, 2023	V 2.5	<ol style="list-style-type: none"> <li>1. Add EM300-MLD and EM300-CL model</li> <li>2. EM300-DI supports pulse conversation, water flow/outage alarm and D2D feature</li> <li>3. Change the pulse definition of EM300-DI uplinks</li> </ol>

# Contents

1. Product Introduction .....	5
1.1 Overview .....	5
1.2 Features .....	5
2. Hardware Introduction .....	5
2.1 Packing List .....	5
2.2 Hardware Overview .....	6
2.3 GPIO Wiring (EM300-DI) .....	6
2.3 Dimensions(mm) .....	6
2.4 Power Button .....	6
3. Operation Guide .....	7
3.1 NFC Configuration .....	7
3.2 LoRaWAN Settings .....	8
3.3 Basic Settings .....	10
3.4 Interface Settings (EM300-DI) .....	11
3.5 Advanced Settings .....	12
3.5.1 Calibration Settings .....	12
3.5.2 Threshold & Alarm Settings .....	12
3.5.3 Data Storage .....	15
3.5.4 Data Retransmission .....	17
3.5.5 Milesight D2D Settings .....	18
3.6 Maintenance .....	19
3.6.1 Upgrade .....	19
3.6.2 Backup .....	20
3.6.3 Reset to Factory Default .....	21
4. Installation .....	22
4.1 EM300 Device Installation .....	22
4.2 Sensor Installation .....	23
5. Device Payload .....	24
5.1 Basic Information .....	24
5.2 Sensor Data .....	25
5.2.1 EM300-TH/MCS/xLD .....	25
5.2.2 EM300-DI .....	26
5.2.3 EM300-CL .....	28
5.3 Downlink Commands .....	28
5.3.1 EM300-TH/MCS/xLD .....	28
5.3.2 EM300-DI .....	30
5.3.3 EM300-CL .....	33
5.4 Historical Data Enquiry .....	34

# 1. Product Introduction

## 1.1 Overview

EM300 series is a sensor mainly used for outdoor environment through wireless LoRaWAN® network. EM300 device is battery powered and designed for multiple mounting ways. It is equipped with NFC (Near Field Communication) and can easily be configured by a smartphone.







Sensor data are transmitted in real-time using standard LoRaWAN® protocol. LoRaWAN® enables encrypted radio transmissions over long distance while consuming very little power. The user can obtain sensor data and view the trend of data change through Milesight IoT Cloud or through the user's own Network Server.

## 1.2 Features

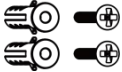
- Up to 11 km communication range
- Easy configuration via NFC
- Standard LoRaWAN® support
- Milesight IoT Cloud compliant
- Low power consumption with 4000mAh replaceable battery

# 2. Hardware Introduction

## 2.1 Packing List

			
1 × EM300 Device (Including Sensor)	2 × Wall Mounting Kits	2 × Screw Caps	1 × Quick Guide
			
1 × Warranty Card	3M Double Sided Tape(SLD, MCS and CL Sensor Only)	Mounting Screws (SLD or MCS Sensor Only)	Cable-tie (CL Sensor Only)



If any of the above items is missing or damaged, please contact your sales representative.

## 2.2 Hardware Overview

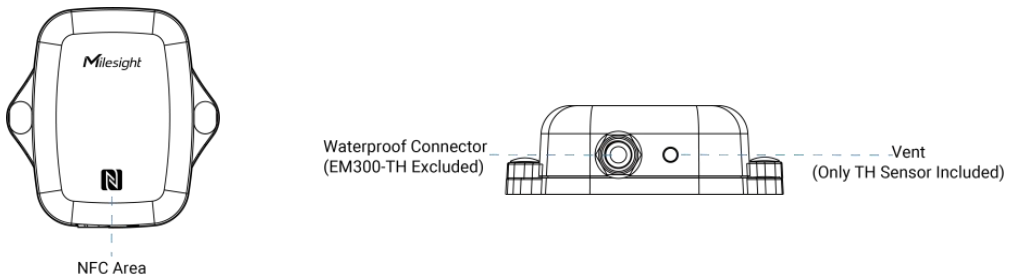

## 2.3 GPIO Wiring (EM300-DI)

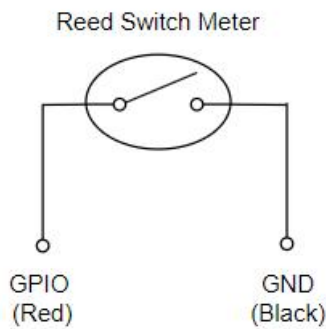

## 2.3 Dimensions(mm)

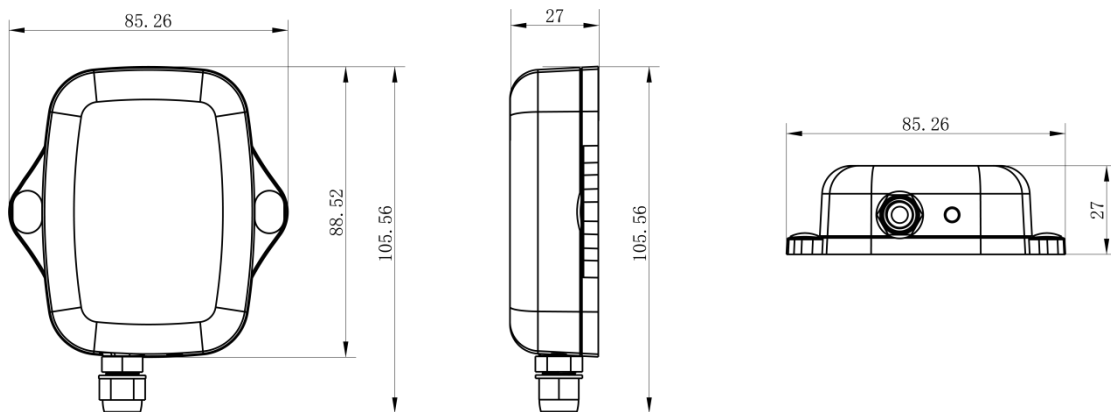

## 2.4 Power Button

**Note:** The LED indicator and power button are inside the device. Turn on/off and reset can also be configured via NFC.

Function	Action	LED Indication
Turn On	Press and hold the button for more than 3 seconds.	Off → On
Turn Off	Press and hold the button for more than 3 seconds.	On → Off
Reset	Press and hold the button for more than 10 seconds.	Blinks quickly.
Check On/Off Status	Quickly press the power button.	Light On: Device is on. Light Off: Device is off.

## 3. Operation Guide

### 3.1 NFC Configuration

EM300 series can be monitored and configured via NFC. Please refer the following steps to complete configuration.

1. Download and install “Milesight ToolBox” App from Google Play or Apple Store.
2. Enable NFC on the smartphone and launch Milesight ToolBox.
3. Attach the smartphone with NFC area to the device and click **NFC Read** to read device information. Basic information and settings of the device will be shown on ToolBox App if it's recognized successfully. You can read and configure the device by tapping the Read/Write device on the App. In order to protect the security of the device, please change password when first configuration. The default password is **123456**.

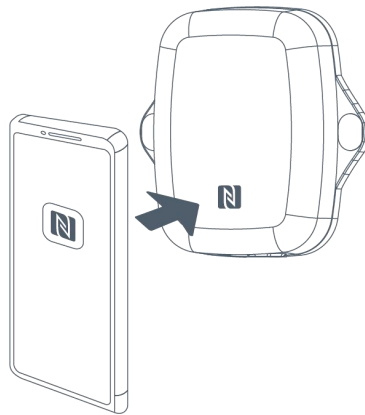

**Note:**

- 1) Ensure the location of smartphone NFC area and it's recommended to take off phone case.
- 2) If the smartphone fails to read/write configurations via NFC, keep the phone away and back to try again.
- 3) EM300 series can also be configured by dedicated NFC reader provided by Milesight IoT or you can configure it via TTL interface inside the device.

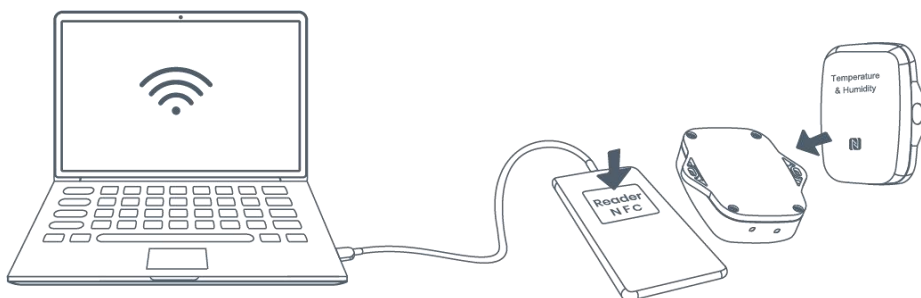

### 3.2 LoRaWAN Settings

EM300 series support to configure join type, App EUI, App Key and other information. You can also keep all settings by default.

Device EUI

\* APP EUI

\* Application Port  85

Join Type

\* Application Key

LoRaWAN Version

Parameters	Description
Device EUI	Unique ID of the device which can also be found on the label.
App EUI	Default App EUI is 24E124C0002A0001.
Application Port	The port used for sending and receiving data, default port is 85.
Join Type	OTAA and ABP mode are available.
Application Key	Appkey for OTAA mode, default is 5572404C696E6B4C6F52613230313823.
Device Address	DevAddr for ABP mode, default is the 5 <sup>th</sup> to 12 <sup>th</sup> digits of SN.
Network Session Key	Nwkskey for ABP mode, default is 5572404C696E6B4C6F52613230313823.
Application Session Key	Appskey for ABP mode, default is 5572404C696E6B4C6F52613230313823.
LoRaWAN Version	V1.0.2 and V1.0.3 are available.
Work Mode	It's fixed as Class A.
RX2 Data Rate	RX2 data rate to receive downlinks or send D2D commands.
RX2 Frequency	RX2 frequency to receive downlinks or send D2D commands. Unit: Hz
Supported Frequency	Enable or disable the frequency to send uplinks. If frequency is one of CN470/AU915/US915, enter the index of the channel to enable in the input box, making them separated by commas.



	<p><b>Examples:</b></p> <p>1, 40: Enabling Channel 1 and Channel 40</p> <p>1-40: Enabling Channel 1 to Channel 40</p> <p>1-40, 60: Enabling Channel 1 to Channel 40 and Channel 60</p> <p>All: Enabling all channels</p> <p>Null: Indicate that all channels are disabled</p> <p>Enable Channel Index ⓘ</p> <p>0-71</p> <table border="1"> <thead> <tr> <th>Index</th> <th>Frequency/MHz ⓘ</th> </tr> </thead> <tbody> <tr> <td>0 - 15</td> <td>902.3 - 905.3</td> </tr> <tr> <td>16 - 31</td> <td>905.5 - 908.5</td> </tr> <tr> <td>32 - 47</td> <td>908.7 - 911.7</td> </tr> <tr> <td>48 - 63</td> <td>911.9 - 914.9</td> </tr> <tr> <td>64 - 71</td> <td>903 - 914.2</td> </tr> </tbody> </table>	Index	Frequency/MHz ⓘ	0 - 15	902.3 - 905.3	16 - 31	905.5 - 908.5	32 - 47	908.7 - 911.7	48 - 63	911.9 - 914.9	64 - 71	903 - 914.2
Index	Frequency/MHz ⓘ												
0 - 15	902.3 - 905.3												
16 - 31	905.5 - 908.5												
32 - 47	908.7 - 911.7												
48 - 63	911.9 - 914.9												
64 - 71	903 - 914.2												
Channel Mode	Select Standard-Channel mode or Single-Channel mode. When Single-Channel mode is enabled, only one channel can be selected to send uplinks.												
Spread Factor	If ADR is disabled, the device will send data via this spread factor.												
Confirmed Mode	If the device does not receive ACK packet from network server, it will resend data once.												
Rejoin Mode	<p>Reporting interval <math>\leq</math> 35 mins: the device will send a specific number of LinkCheckReq MAC packets to the network server every reporting interval or every double reporting interval to validate connectivity; If there is no response, the device will re-join the network.</p> <p>Reporting interval <math>&gt;</math> 35 mins: the device will send a specific number of LinkCheckReq MAC packets to the network server every reporting interval to validate connectivity; If there is no response, the device will re-join the network.</p>												
Set the number of packets sent	<p>When the rejoin mode is enabled, set the number of LinkCheckReq packets to send.</p> <p><b>Note:</b> the actual sending number is <b>Set the number of packet sent + 1</b>.</p>												

ADR Mode	Allow network server to adjust datarate of the device.
Tx Power	Transmit power of device.

**Note:**

- 1) Please contact sales for device EUI list if there are many units.
- 2) Please contact sales if you need random App keys before purchase.
- 3) Select OTAA mode if you use Milesight IoT Cloud to manage devices.
- 4) Only OTAA mode supports rejoin mode.

### 3.3 Basic Settings

Go to **Device > Setting > General Settings** to change the reporting interval, etc.

Parameters	Description
Reporting Interval	Reporting interval of transmitting current sensor values to network server. Range: 1-1080 mins, Default: 10 mins (EM300-TH/MCS/SLD/ZLD/DI), 1080 mins (EM300-MLD)
Temperature Unit	Change the temperature unit displayed on the ToolBox. <b>Note:</b> 1) The temperature unit in the reporting package is fixed as Celsius(°C). 2) Please modify the threshold settings if the unit is changed.
<a href="#">Data Storage</a>	Disable or enable data storage locally.
<a href="#">Data Retransmission</a>	Disable or enable data retransmission.
Change Password	Change the password for ToolBox App to write this device.

**EM300-CL:**

## General Settings

Reporting Interval  min

Full Liquid Calibration

Change Password

Parameters	Description
Reporting Interval	Reporting interval of transmitting battery level and liquid status to network server. Range: 1-1440 mins, Default: 1440 mins
Full Liquid Calibration	When the liquid is full, click the <b>Calibrate</b> button to record the full status. After calibrated, the device will report a calibration result packet. <b>Note:</b> 1) The device will calibrate once automatically after turning on 20 minutes. 2) The alarm feature will not work if liquid calibration did not proceed. 3) Please re-calibrate it if the full liquid height changes.
Change Password	Change the password for ToolBox App to write this device.

### 3.4 Interface Settings (EM300-DI)

Go to **Device > Settings > Interface Settings** to modify configurations.

Interface Type

Counter

Pulse Filter

Modify count value

Pulse Value Conversion

L =  Pulse

Parameters	Description
Interface Type	Change the interface type of GPIO interface as Counter or Digital.

Pulse Filter	When the function is enabled, pulse with a rate of more than 250us can be counted.
Modify Count Value	Set the initial counting value.
Pulse Value Conversion	<p>Set the value that converts pulses to a specific water consumption.</p> <p><input type="text" value="1"/> <input type="text" value="L"/> = <input type="text" value="40"/> Pulse</p> <p>Water_conv    Unit            Pulse_conv</p> <p><b>Note: water_conv=water conversion value, pulse_conv=pules conversion value.</b></p>

## 3.5 Advanced Settings

### 3.5.1 Calibration Settings

EM300-TH/MCS/SLD/ZLD/DI supports temperature and humidity calibration. The device will add the calibration value to raw value and upload the final values to network server.

**Temperature**

**Numerical Calibration**

Current Value: 0 °C

Calibration Value

°C

Final Value: -1 °C

**Humidity**

### 3.5.2 Threshold & Alarm Settings

EM300 series supports various types of alarm settings.

#### 1) Temperature Threshold Alarm:

EM300-TH/MCS/SLD/ZLD/DI supports temperature threshold alarm settings. When current temperature is over or below the threshold value, the device will report the threshold alarm packet once instantly. Only when the threshold alarm is dismissed and re-triggered, the device will report the alarm again.

**Temperature**

Over / °C

Below / °C

Collecting Interval  1  min

Parameters	Description
Collect Interval	The interval to detect temperature after threshold alarm triggers. This interval should be less than reporting interval.

## 2) EM300-MCS/SLD/ZLD/MLD:

### Alarm Settings

**Alarm Reporting**

If someone invades, the alarm reporting interval and the alarm reporting times can be set as follows

Alarm Reporting Interval  1  min

Alarm Reporting Times  2

Parameters	Description
Alarm Reporting	After enabled, the device will report the alarm packet when the door status changes to open or water is detected to leak.
Alarm Reporting Interval	The interval to report digital status after alarm triggers. This interval should be less than reporting interval.
Alarm Reporting Times	Alarm packet report times after alarm triggers.

## 3) EM300-DI:

When interface type is Digital:

Alarm Settings Alarm Reporting 

Alarm Options

Low→High Alarm Reporting Interval  1  minAlarm Reporting Times  2 

Parameters	Description
Alarm Reporting	After enabled, the device will report the alarm packet according to digital change options.
Alarm Reporting Interval	The interval to report digital status after alarm triggers. This interval should be less than reporting interval.
Alarm Reporting Times	Alarm packet report times after alarm triggers.

When interface type is Pulse:

Threshold Settings Temperature Water Flow Duration for Water Flow Determination /s 

0

Water Flow Timeout Alarm  

Timeout Interval /Min

Water Outage Timeout Alarm  

Timeout Interval /Min

Parameters	Description
Duration for Water Flow Determination/s	If the pulse counter does not increase for this duration time, the device will judge current status as "Water Outage"; otherwise, the device will judge current status as "Water Flow".

Water Flow Timeout Alarm	If the "Water Flow" status has passed the timeout interval, the device will report a water flow timeout alarm packet. If the water flow status stops during next timeout interval, the device will report the alarm dismiss packet; otherwise, it will report an alarm packet again.
Water Outage Timeout Alarm	If the "Water Outage" status has passed the timeout interval, the device will report a water outage timeout alarm packet. If the water outage status stops during next timeout interval, the device will report the alarm dismiss packet; otherwise, it will report an alarm packet again.

#### 4) EM300-CL:

Alarm Settings ^

---

**Alarm Reporting**

Status Detection Interval  min

Alarm Reporting Times

Alarm Dismiss Report

Parameters	Description
Alarm Reporting	After enabled, the device will report the alarm packet when the liquid level of container is lower than the installation height of detection electrode sheet.
Status Detection Interval	The interval to detect liquid status after alarm triggers.
Alarm Reporting Times	Alarm packet report times after alarm triggers.
Alarm Dismiss Report	After enabled, the device will report the alarm dismiss packet once when the liquid of container is changed to full.

### 3.5.3 Data Storage

EM300 series (except EM300-CL) supports storing data records locally and exporting data via ToolBox App. The device will record the data according to reporting interval and even join network.

1. Go to **Device > Status** of ToolBox App to click **Sync** to sync the time.

Device Status	ON <input checked="" type="checkbox"/>
Join Status	De-activated
RSSI/SNR	-32/11
Device Time	2022-10-31 17:10 <span style="border: 1px solid red; padding: 2px;">Sync</span>

Besides, when device LoRaWAN® version is set as 1.0.3, the device will send MAC commands to ask the network server for the time every time it joins the network.

2. Go to **Device > Setting > General Settings** to enable data storage feature.

Temperature Unit i

°C ▼

Reporting Interval - 10 + min

Data Storage i

3. Go to **Device > Maintenance**, click **Export**, then select the data time range and click **Confirm** to export data. ToolBox App can only export last 14 days' data.

Status	Setting	Maintenance
SN		
Model	EM300-DI-915M	
Firmware Version	V1.1-a3	
Hardware Version	V3.0	
Manual Upgrade		

Cancel    Export Data Period    Confirm

2022-10-06 10:36 To 2022-10-20 10:36

↶

Year	Month	Day	Hour	Minute
2020	8	4	8	34
2021	9	5	9	35
2022	10	6	10	36



### 3.5.4 Data Retransmission

EM300 series (except EM300-CL) supports data retransmission to ensure network server can get all data even if network is down for some times. There are two ways to get the lost data:

- Network server sends downlink commands to enquire the historical data for specifying time range, see section [Historical Data Enquiry](#);
- When network is down if no response from LinkCheckReq MAC packets for a period of time, the device will record the network disconnected time and re-transmit the lost data after device re-connects the network.

Here are the steps for data retransmission:

1. Enable data storage feature and data retransmission feature;

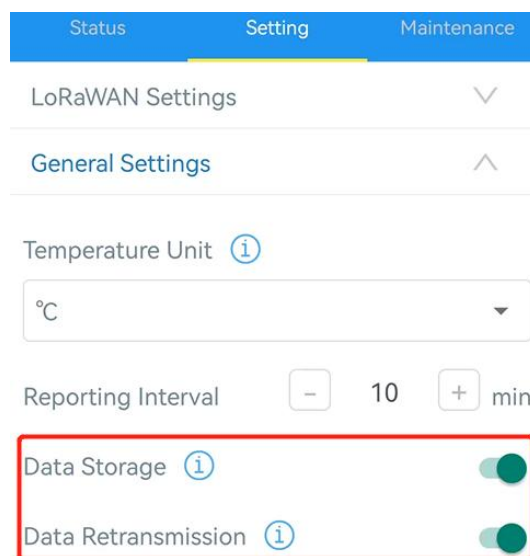

2. Go to **Device > Setting > General Settings** to enable rejoin mode feature and set the number of packets sent. Take below as an example, the device will send LinkCheckReq MAC packets to the network server regularly to check for any network disconnection; if there is no response for 8+1 times, the join status will change to de-active and the device will record a data lost time point (the time it reconnected to the network).

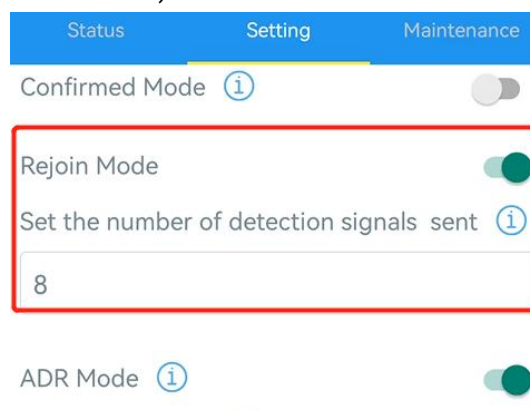

3. After the network connected back, the device will send the lost data from the point in time

when the data was lost according to the reporting interval.

**Note:**

- 1) If the device is rebooted or re-power when data retransmission is not completed, the device will re-send all retransmission data again after device is reconnected to the network;
- 2) If the network is disconnected again during data retransmission, it will only send the latest disconnected data;
- 3) The retransmission data format is started with "20ce" or "21ce", please refer to see section [Historical Data Enquiry](#).
- 4) Data retransmission will increase the uplinks and shorten the battery life.

### 3.5.5 Milesight D2D Settings

Milesight D2D protocol is developed by Milesight and used for setting up transmission among Milesight devices without gateway. When the Milesight D2D settings is enabled, EM300 series (except EM300-CL) can work as D2D controller to send control commands to trigger Milesight D2D agent devices.

1. Configure RX2 datarate and RX2 frequency in LoRaWAN<sup>®</sup> settings, it is suggested to change the default value if there are many LoRaWAN<sup>®</sup> devices around.
2. Go to **Device > Setting > D2D Settings** to enable Milesight D2D feature.
3. Define an unique D2D key which is the same as Milesight D2D agent devices. (Default D2D key: 5572404C696E6B4C6F52613230313823)

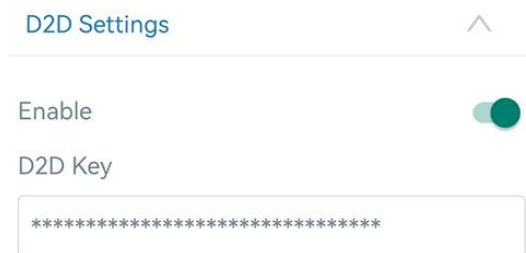

4. Enable one of status mode and configure 2-byte hexadecimal Milesight D2D command. When the status is triggered, EM300 series sensor will send this control command to corresponding Milesight D2D agent devices. Take EM300-ZLD as example below:

Sensor Status: Leak

Control command

LoRa Uplink ⓘ

Sensor Status: No Leak

Temperature Threshold Trigger Status: Trigger

Temperature Threshold Trigger Status: not triggered

**Note:**

- 1) If you enable **LoRa Uplink**, a LoRaWAN® uplink packet that contains corresponding alarm status will be sent to gateway after the Milesight D2D control command packet. Otherwise, the alarm packet will not send to LoRaWAN® gateway.
- 2) If you want to enable **Temperature Threshold Trigger Status: Trigger** or **Temperature Threshold Trigger Status: not triggered**, please enable and configure temperature threshold feature under **Threshold Settings**.
- 3) For EM300-DI, if you want to enable water flow or outage settings, please enable and configure water flow threshold feature under **Threshold Settings**.

## 3.6 Maintenance

### 3.6.1 Upgrade

1. Download firmware from Milesight website to your smartphone.
2. Open Toolbox App and click **Browse** to import firmware and upgrade the device.

**Note:**

- 1) Operation on ToolBox is not supported during an upgrade.
- 2) Only Android version ToolBox supports the upgrade feature.

Status	Setting	Maintenance
SN	6136B26167392109	
Model	EM300-ZLD-915M	
Firmware Version	V1.1-a1	
Hardware Version	V3.0	
Manual Upgrade		

[Browse](#)



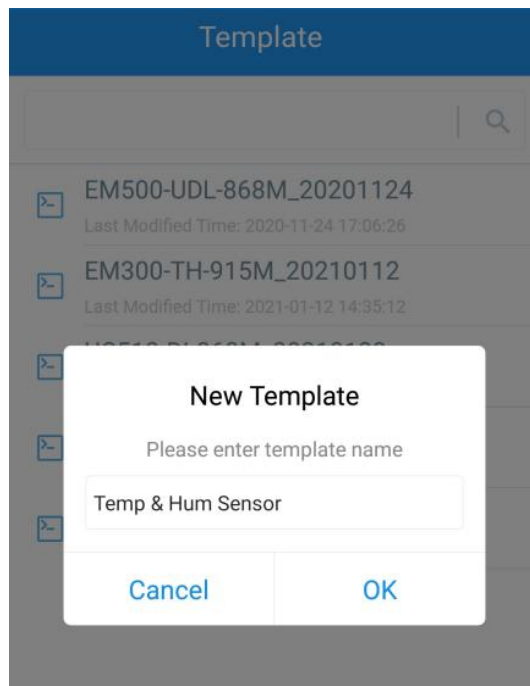

### 3.6.2 Backup

EM300 devices support configuration backup for easy and quick device configuration in bulk. Backup is allowed only for devices with the same model and LoRaWAN® frequency band.

1. Go to **Template** page on the App and save current settings as a template. You can also edit the template file.
2. Select one template file which saved in the smartphone and click **Write**, then attach to another device to write configuration.



**Note:** Slide the template item left to edit or delete the template. Click the template to edit the configurations.

Template	
	EM500-UDL-868M_20201124 Last Modified Time: 2020-11-24 17:06:26
	EM300-TH-915M_20210112 Last Modified Time: 2021-01-12 14:35:12
	UC512-DI-868M_20210128 Last Modified Time: 2021-01-28 16:57:20
	UC501-470M_20210201 Last Modified Time: 2021-02-01 11:29:43
	V_20210208 Last Modified Time: 2021-02-08 16:44:37
	<a href="#">Edit</a> <a href="#">Delete</a>

### 3.6.3 Reset to Factory Default

Please select one of following methods to reset device:

**Via Hardware:** Hold on power button (internal) for more than 10s until LED blinks.

**Via ToolBox App:** Go to **Device > Maintenance** to click **Reset**, then attach smart phone with NFC area to device to complete reset.

Status	Setting	Maintenance
SN	6136B26167392109	
Model	EM300-ZLD-915M	
Firmware Version	V1.1-a1	
Hardware Version	V3.0	
Manual Upgrade		
<a href="#">Browse</a>		
Restore Factory Default		
<a href="#">Reset</a>		

**Note:** Reset operation will not clean the stored data, please click **Data Cleaning** to clear data if necessary.

Status	Setting	Maintenance
Firmware Version		V1.1-a3
Hardware Version		V3.0
Manual Upgrade		
Browse		
Restore Factory Default		
Reset		
Export Historical Data		
Export		
Export Record		
Data Cleaning		

## 4. Installation

### 4.1 EM300 Device Installation

1. Attach EM300 device to the wall and mark the two holes on the wall. The connecting line of two holes must be a horizontal line.
2. Drill the holes according to the marks and screw the wall plugs into the wall.
3. Mount the EM300 to the wall via mounting screws.
4. Cover the mounting screws with screw caps.

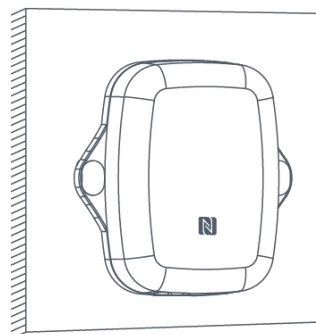
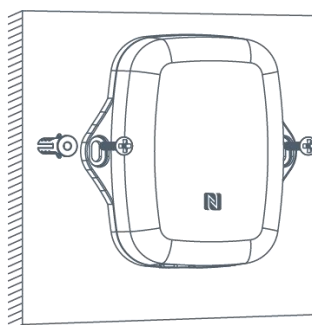

Besides, it can also be mounted to a wall via 3M tape or be mounted to a pole via cable-tie.

## 4.2 Sensor Installation

- **EM300-MLD/SLD/ZLD**

Refer to *Water Leakage Sensor Installation Guide*.

- **EM300-MCS**

Fix the two magnet parts with 3M tape or screws, the two parts should be aligned.

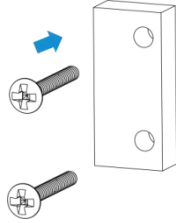

Fixed by Screws

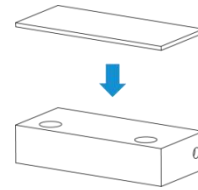

Fixed by 3M Tape

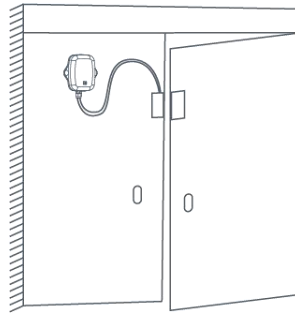

- **EM300-CL**

Attach the detection electrode sheet to the wall of the container seamlessly, aligning it with the **bottom** of the container to detect the liquid capacity. The detection electrode sheet can be fixed to the container wall using 3M tape, and then covered with protective foam on the outside. Or you can first attach the protective foam to the outside of the detection electrode sheet and then fix them to the container wall using a cable tie.

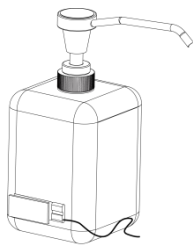

Fixed by 3M Tape

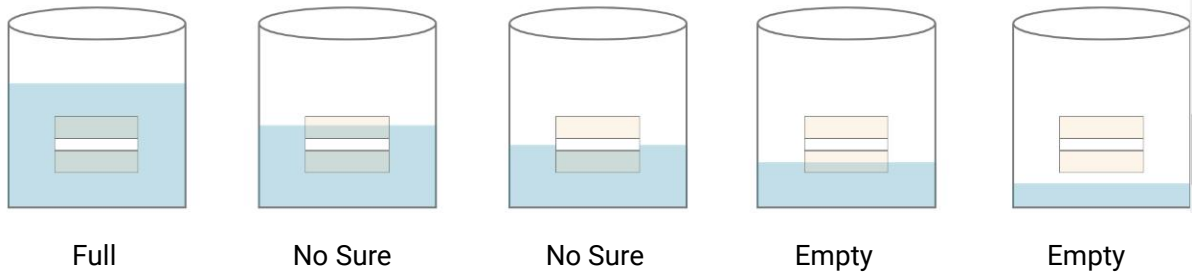

Fixed by Cable-tie

**Note:**

- 1) This product is not applicable to metal conductive metal containers, absorbent non-metal material containers (cement, wood board, ceramic, tiles, bricks, etc.) or liquid in bags.
- 2) This product is applicable to the containers made up of insulating non-metallic materials and with flat surfaces and uniform thickness, like plastic, glass, acrylic, etc.
- 3) It is suggested that the side walls of container do not exceed 3mm.
- 4) Avoid the detection electrode sheet facing the liquid inlet or the path of the liquid inlet flow.
- 5) Clean the container to avoid the detection results to be affected by silt or other debris.
- 6) Avoid detection electrode sheet to be attached by detection liquids, or this will affect the detection results.
- 7) If the detection liquid is too thick, it will hang to the side wall of container, and will delay the time of leak detection and alarm.
- 8) Keep the distance of both detection electrode sheets more than 15cm to avoid detection interference if you have two EM300-CL sensors.

## 5. Device Payload

All data are based on following format (HEX), the Data field should follow little-endian:

Channel1	Type1	Data1	Channel2	Type2	Data2	Channel 3	...
1 Byte	1 Byte	N Bytes	1 Byte	1 Byte	M Bytes	1 Byte	...

For decoder examples please find files on <https://github.com/Milesight-IoT/SensorDecoders>.

### 5.1 Basic Information

EM300 series sensors report basic information of sensor whenever joining the network.

Channel	Type	Description
ff	0b (Power On)	ff, this means the device is on
	01 (Protocol Version)	01=>V1
	09 (Hardware Version)	01 40 => V1.4
	0a (Software Version)	01 14 => V1.14
	0f (Device Type)	00: Class A, 01: Class B, 02: Class C
	16 (Device SN)	16 digits

**Example:**



ff0bff ff0101 ff166136c40091605408 ff090300 ff0a0101 ff0f00					
Channel	Type	Value	Channel	Type	Value
ff	0b (Power On)	ff	ff	01 (Protocol Version)	01 (V1)
Channel	Type	Value	Channel	Type	Value
ff	16 (Device SN)	6136c400916054 08	ff	09 (Hardware Version)	0300 (V3.0)
Channel	Type	Value	Channel	Type	Value
ff	0a (Software Version)	0101 (V1.1)	ff	0f (Device Type)	00 (Class A)

## 5.2 Sensor Data

### 5.2.1 EM300-TH/MCS/xLD

Item	Channel	Type	Description
Battery Level	01	75	UINT8, Unit: %
Temperature	03	67	INT16/10, Unit: °C
Humidity	04	68	UINT8/2, Unit: %RH
Water Leakage	05	00	00: Not leak, 01: Leaked
Magnet Status	06	00	00: Close, 01: Open (Separate)

#### Examples:

1. Periodic packet: reports according to reporting interval.

#### EM300-MCS:

03671001 046871 060000					
Channel	Type	Value	Channel	Type	Value
03	67 (Temperature)	10 01 => 01 10 = 272/10=27.2°C	04	68 (Humidity)	113/2=56.5%RH
Channel	Type	Value			
06	00	00=close			

#### EM300-MLD:

05 00 00		
Channel	Type	Value
05	00(Water Leakage Status)	00=No leak

2. Battery level packet:
  - 1) Report once with sensor data after joining the network;
  - 2) Report every 6 hours;
  - 3) Report once when the battery level is below 10%.

01 75 64		
Channel	Type	Value
01	75(Battery)	64 => 100%

3. Temperature threshold alarm packet: reports once when temperature reaches the threshold.

03671001		
Channel	Type	Value
03	67	10 01 => 01 10 = 272/10=27.2°C

4. Magnet or water leakage change packet: reports the change immediately and according to alarm settings.

03671001 046871 050001					
Channel	Type	Value	Channel	Type	Value
03	67 (Temperature)	10 01 => 01 10 = 272/10=27.2°C	04	68 (Humidity)	113/2=56.5%RH
Channel	Type	Value			
05	00(Water Leakage Status)	01=>Water is leaked			

### 5.2.2 EM300-DI

Item	Channel	Type	Description
Battery Level	01	75	UINT8, Unit: %
Temperature	03	67	INT16/10, Unit: °C
Humidity	04	68	UINT8/2, Unit: %RH
Digital Input	05	00	00: Low, 01: High
Pulse Counter	05	c8	UINT32, for firmware V1.2 and before
Pulse Counter	05	e1	8 Bytes, water_conv(2B) + pulse_conv (2B) + Water consumption (4B) Water/Pulse_conv: UINT16/10, see description on <a href="#">Pulse Value Conversion</a> Water consumption: Float32 <b>Note:</b> 1) Water consumption=Water_conv/pulse_conv * pulse counter value; 2) If pulse value conversion is disabled, water_conv and pulse_conv are fixed as 0x0a00 (10), and the water consumption=pulse counter value.

DI Alarm	85	00	2 Bytes, Byte 1: 01=High, 00=Low, Byte 2: 01=Alarm, 00=Alarm dismiss
Pulse Alarm	85	e1	9 Bytes, water_conv(2B) + pulse_conv (2B) + Water consumption (4B) + Alarm Status (1B) Alarm Status: 01-Water outage timeout alarm 02-Water outage timeout alarm dismiss 03-Water flow timeout alarm 04-Water flow timeout alarm dismiss

**Examples:**

1. Periodic packet: reports according to reporting interval (10 min by default).

**EM300-DI (Digital)**

03671e01 046894 050001					
Channel	Type	Value	Channel	Type	Value
03	67 (Temperature)	1e 01 => 01 1e = 286/10=28.6°C	04	68 (Humidity)	94/2=47%RH
Channel	Type	Value			
05	00	01=High			

**EM300-DI (Counter)**

03671e01 046894 05e10a000a0000005b43					
Channel	Type	Value	Channel	Type	Value
03	67 (Temperature)	1e 01 => 01 1e = 286/10=28.6°C	04	68 (Humidity)	94/2=47%
Channel	Type	Value			
05	e1(Counter)	Water_conv & Pulse_conv: 0a00=>10/10=1 Water consumption: 00 00 5b 43=>43 5b 00 00=219			

2. Temperature threshold alarm packet: reports once when temperature reaches the threshold.

03671001		
Channel	Type	Value
03	67 (Temperature)	10 01 => 01 10 = 272 *0.1=27.2°C

3. Pulse alarm packet: reports the change immediately and according to threshold settings.

85e10a000a0000005b43 01		
Channel	Type	Value

85	e1(Counter)	Water_conv & Pulse_conv: 0a00=>10/10=1 Water consumption: 00 00 5b 43=>43 5b 00 00=219 Alarm Status: 01-Water outage timeout alarm
----	-------------	--

### 5.2.3 EM300-CL

Item	Channel	Type	Description
Battery Level	01	75	UINT8, Unit: %
Liquid Level Status	03	ed	00: Uncalibrated, 01: Full, 02: Empty, ff: Sensor error or not connect
Calibration Status	04	ee	00: Failure; 01: Success
Liquid Level Alarm	83	ed	2 Bytes, Byte 1: 00=Uncalibrated, 01=Full, 02=Empty, ff=Sensor error or not connect Byte 2: 01=Alarm, 00=Alarm dismiss

#### Examples:

1. Periodic packet: reports according to reporting interval (1440 min by default).

017564 03ed01					
Channel	Type	Value	Channel	Type	Value
01	75	Battery level: 64 => 100%	03	ed	Liquid status: 01=full

2. Alarm packet: reports according to alarm settings.

83ed00		
Channel	Type	Value
83	ed	Liquid status: 01=empty

## 5.3 Downlink Commands

EM300 series sensors support downlink commands to configure the device. The application port is 85 by default.

### 5.3.1 EM300-TH/MCS/xLD

Command	Channel	Type	Description
Reboot	ff	10	ff
Collect Interval	ff	02	2 Bytes, unit: s
Report Interval	ff	03	2 Bytes, unit: s
Threshold Alarm	ff	06	9 Bytes, CTRL (1B) + Min (2B) + Max (2B) +00000000(4B)

			<b>CTRL:</b> Bit2~0: 000 - disable 001 - below (minimum threshold) 010 - over (maximum threshold) 011 - within 100 - below or over Bit 5~3: 001 - Temperature 010 - Magnet or water leakage Bit 7~6: 00
D2D Setting	ff	79	4 Bytes, Number(1B)+Function(1B)+D2D Command(2B) <b>Number:</b> 01 -Temperature threshold trigger 02 -Temperature threshold doesn't trigger 03 - Status trigger 04 -Status doesn't trigger <b>Function:</b> 00 -Disable 01 -Only use D2D 03 -Use D2D&LoRaWAN Uplink
Data Storage	ff	68	00: disable, 01: enable
Data Retransmission	ff	69	00: disable, 01: enable
Data Retransmission Interval	ff	6a	3 Bytes Byte 1: 00 Byte 2-3: interval time, unit: s range: 30~1200s (600s by default)

**Examples:**

1. Set reporting interval as 20 minutes.

ff03b004

Channel	Type	Value
ff	03 (Report Interval)	b0 04 => 04 b0 = 1200s= 20 minutes

2. Reboot the device.

ff10ff		
Channel	Type	Value
ff	10 (Reboot)	ff (Reserved)

3. Set a temperature threshold as below 15°C or over 30°C.

ff 06 0c96002c0100000000		
Channel	Type	Value
ff	06 (Set Threshold Alarm)	CTRL:0c =>00 001 100 001=temperature threshold 100 = below or over Min:96 00=> 00 96 =150/10= 15°C Max: 2c 01=>01 2c = 300/10=30°C

4. Set D2D settings of temperature threshold trigger.

ff 79 01011001		
Channel	Type	Value
ff	79 (D2D settings )	Number: 01=temperature threshold trigger Function: 01=only use D2D D2D Command: 1001=>0110

### 5.3.2 EM300-DI

Command	Channel	Type	Description
Reboot	ff	10	ff
Collect Interval	ff	02	2 Bytes, unit: s
Report Interval	ff	03	2 Bytes, unit: s
UTC Time Zone	ff	17	2 Bytes, INT16/10
Data Storage	ff	68	00: disable, 01: enable
Data Retransmission	ff	69	00: disable, 01: enable
Data Retransmission Interval	ff	6a	3 Bytes Byte 1: 00 Byte 2-3: interval time, unit: s range: 30~1200s (600s by default)
Interface Type	ff	c3	01: Digital, 02: Counter

Pulse Digital Filter	ff	a3	0100-disable, 0101-enable
Modify Initial counting value	ff	92	01+Initial counting value (4B)
Pulse Value Conversion	ff	a2	9 Bytes Byte 1: 00=disable, 01=enable Byte 2-3: Water_conv Byte 4-5: Pulse_conv Byte 6-9: Unit, ASCII code
Pulse counter	ff	4e	0100-Clean the count 0101-Stop counting 0102-Start counting
Temperature Threshold Alarm	ff	06	9 Bytes, CTRL (1B) + Min (2B) + Max (2B) +00000000(4B) CTRL: Bit2~0: 000 - disable 001 - below (minimum threshold) 010 - over (maximum threshold) 011 - within 100 - below or over Bit 7~3: 00001
Water Flow Threshold Alarm	ff	a1	7 Bytes, 01+Number (1B)+Enable(1B)+Timeout Interval (4B) <b>Number:</b> 00 -Water flow threshold setting 01 -Water flow timeout alarm 02 -Water outage timeout alarm <b>Enable:</b> 00 -Disable, 01 -Enable <b>Timeout Interval:</b> UINT32, unit: min
Duration for Water Flow Determination	ff	a4	2 Bytes, unit: s
D2D Setting	ff	79	4 Bytes, Number(1B)+Enable(1B)+D2D Command(2B) <b>Number:</b> 01 -Water outage timeout alarm

			02 -Water outage timeout alarm release 03 -Water flow timeout alarm 04 -Water flow timeout alarm release 05-DI from low to high 06-DI from high to low <b>Enable:</b> 00 -Disable 01 -Only use D2D 03 -Use D2D&LoRaWAN Uplink
--	--	--	---

**Example:s**

1. Set reporting interval as 20 minutes.

ff03b004		
Channel	Type	Value
ff	03	b0 04 => 04 b0 = 1200s= 20 minutes

2. Reboot the device.

ff10ff		
Channel	Type	Value
ff	10	ff (Reserved)

3. Set time zone.

ff17ecff		
Channel	Type	Value
ff	17	ec ff => ff ec = -20/10=-2 The time zone is UTC-2

4. Set pulse conversion: 1ml=10 pulses.

ffa2 01 0a00 6400 6d6c0000		
Channel	Type	Value
ff	a2	01=Enable Water_conv: 0a00=>00 0a=10/10=1 Pulse_conv: 6400=>0064=100/10=10 Unit: 6d 6c 00 00=>ml (hex to ascii)

5. Set a temperature threshold as below 15°C or over 30°C.

ff 06 0c96002c0100000000		
Channel	Type	Value
ff	06	CTRL:0c =>11 001 100



		<p>100 = below or above  Min:96 00=&gt; 00 96 =150/10= 15°C  Max: 2c 01=&gt;01 2c = 300/10=30°C</p>
--	--	---

6. Enable water outage timeout alarm and set timeout interval as 10 minutes.

ffa1 01 0001 00000000 ff a1 01 0201 0a000000		
Channel	Type	Value
ff	a1	00=Water flow threshold setting 01=Enable
ff	a1	02=Water outage timeout alarm 01=Enable 0a 00 00 00=>00 00 00 0a=10 minutes

7. Set D2D settings of water outage timeout alarm.

ff 79 01011001		
Channel	Type	Value
ff	79	Number: 01=Water outage timeout alarm Function: 01=Enable D2D D2D Command: 1001=>0110

### 5.3.3 EM300-CL

Command	Channel	Type	Description
Reboot	ff	10	ff
Reporting Interval	ff	8e	00 + Interval Time(2B), unit: min
Status Detection Interval	ff	bb	00 + Interval Time(2B), unit: min <b>Note:</b> this interval time should be less than reporting interval.
Alarm Reporting	ff	7e	5 Bytes, CTRL (1B) + 0000 + Alarm Reporting Times (2B) CTRL: 00=Disable, 01=Enable alarm reporting, disable alarm dismiss report 81=Enable alarm reporting and alarm dismiss report
Full Liquid Calibration	ff	62	ff

**Examples:**

1. Set reporting interval as 20 minutes.

ff8e 00 1400		
Channel	Type	Value
ff	8e (Reporting Interval)	14 00=>00 14=>20 mins

2. Reboot the device.

ff10ff		
Channel	Type	Value
ff	10 (Reboot)	ff

3. Enable alarm reporting, set reporting times as 5 and enable alarm dismiss report .

ff7e 81 0000 0500		
Channel	Type	Value
ff	7e	81=Enable alarm reporting and alarm dismiss report 0500=>00 05=5 reporting times

## 5.4 Historical Data Enquiry

EM300 series sensor supports sending downlink commands to enquire historical data for specified time point or time range. Before that, ensure **the device time is correct and data storage feature was enabled to store the data.**

### Command format:

Channel	Type	Description
fd	6b (Enquire data in time point)	4 Bytes, unix timestamp
fd	6c (Enquire data in time range)	Start time (4 bytes) + End time (4 bytes), Unix timestamp
fd	6d (Stop query data report)	ff
ff	6a (Report Interval)	3 Bytes, Byte 1: 01 Byte 2: interval time, unit: s, range: 30~1200s (60s by default)

### Reply format:

Channel	Type	Description
fc	6b/6c	00: data enquiry success 01: time point or time range invalid 02: no data in this time or time range

20	ce (Historical Data)	Data time stamp (4B) + Data Contents (Mutable)
21	ce (EM300-DI Historical Data)	Data time stamp (4B) + Temperature(2B) + Humidity(1B) + Alarm Type (1B) + Interface Type(1B) + Digital(1B) + Water_conv (2B) + Pulse_conv (2B) + Water consumption(4B)

**Data format:**

Sensor	Description
EM300-TH	Temperature(2B) + Humidity(1B)
EM300-MCS	Temperature(2B) + Humidity(1B) + Door Status(1B)
EM300-SLD/EM300-ZLD	Temperature(2B) + Humidity(1B) + Leakage Status(1B)
EM300-MLD	Leakage Status(1B)
EM300-DI (With firmware version 1.2 and before)	Temperature(2B) + Humidity(1B) + Interface Type(1B) + Counter(4B) + Digital(1B)

**Note:**

1. For EM300-DI model:

**Interface Type:** 00=digital, 01=counter

**Alarm Type:** 00=No, 01=water outage timeout alarm, 02=water outage timeout dismiss alarm, 03=water flow timeout alarm, 04=water flow timeout dismiss alarm, 05=DI alarm, 06=DI dismiss alarm.

2. The device only uploads no more than 300 data records per range enquiry.

3. When enquiring the data in time point, it will upload the data which is closest to the search point within the reporting interval range. For example, if the device's reporting interval is 10 minutes and users send command to search for 17:00's data, if the device find there is data stored in 17:00, it will upload this data; if not, it will search for data between 16:50 to 17:00 and upload the data which is closest to 17:00.

**Example:**

1. Enquire historical data between 2022/10/28 14:15:00 to 2022/10/28 15:45:00.

fd6c 64735b63 7c885b63		
Channel	Type	Value
fd	6c (Enquire data in time range)	Start time: 64735b63 => 635b7364 = 1666937700 =2022/10/28 14:15:00 End time: 7c885b63 => 635b887c = 1666943100 =2022/10/28 15:45:00

Reply:

fc6c00		
Channel	Type	Value

fc	6c (Enquire data in time range)	00: data enquiry success
----	---------------------------------	--------------------------

21ce 0d755b63 0801 57 00 02 00 0a00 6400 3333af41			
Channel	Type	Time Stamp	Value
21	ce (EM300-DI Historical Data)	0d755b63 => 2022/10/28 14:22:05	Temperature: 0801=>0108=26.4 °C Humidity: 57=>87=43.5%RH Alarm Type: 00=No Interface Type: 02=Counter Digital: None Water_conv: 0a00=>000a=10/10=1 Pulse_conv: 6400=>0064=100/10=10 Water consumption: 3333af41=>41af3333=21.9

-END-