

Assembly Instruction

MONTERINGSANVISNING | MONTAGEANLEITUNGEN

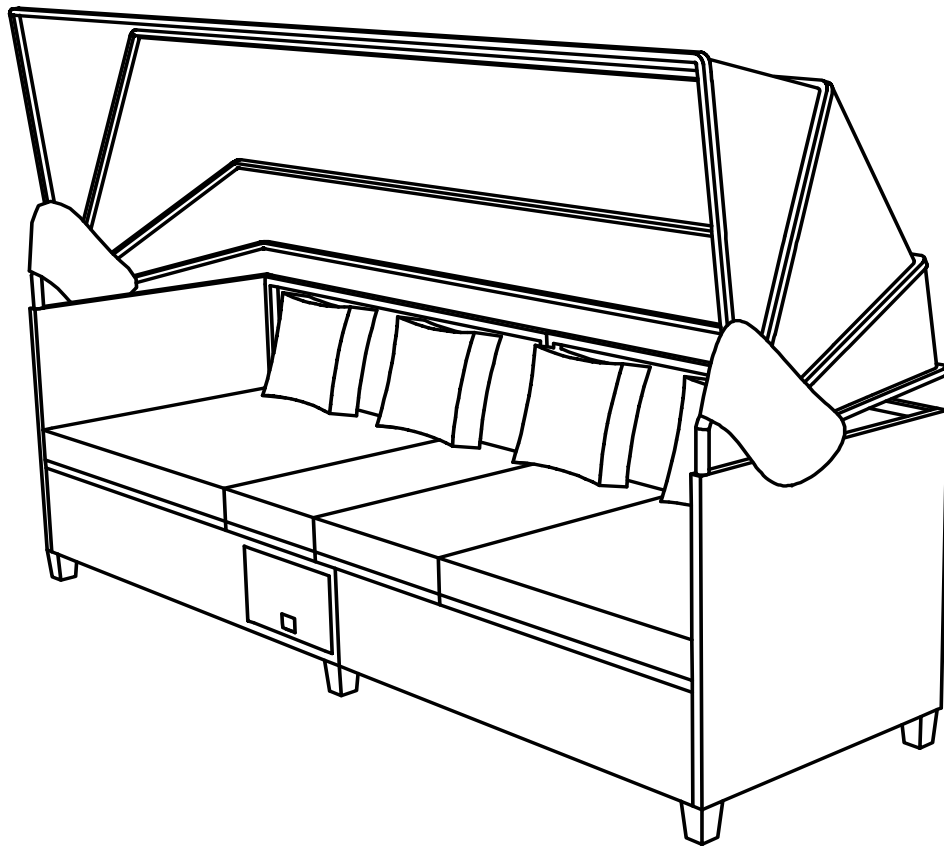

Product Number: 2067-001

Description: Nopy Sun Lounge with Canopy - Black / Grey

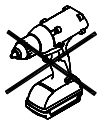

@Venturehomese
@Venture.Design

Do not tighten screws until all
screws have been assembled!

**Venture
home**





Hej!

Grattis till din nya utemöbel.

På detta blad finner du några tips och tricks för att ta hand om din möbel på bästa sätt.

Stål – Stommen i din möbel är antingen i aluminium eller stål. Stål är lite tyngre men är också ett hårdare material än aluminium och klarar därför konstruktioner som aluminium inte klarar. Möbler med stål i stommen kan rosta, framförallt om de står i kustområden där saltvattnet hjälper till att påskynda rosten. Det är därför viktigt att vara aktsam om vilket underlag din möbel står på för att undvika missfärgningar.

Aluminum - Aluminium är ett lättare material än stål och gör din möbel lätt och smidig, detta material skall heller inte rosta. Vissa delar i din möbel kan dock fortfarande vara gjorda av stål (exempelvis skruvar eller beslag)

Konstrotting – Detta material är en plast som är mycket tålig när det kommer till väder och vind och är i mångt och mycket underhållsfritt. Behöver du tvätta av din konstrottingmöbel gör du detta enklast med vatten och såpa.

Teak – Våra teakmöbler produceras av odlad teak. Dvs. Teak som är odlad för ändamålet att bli till möbler eller annat, det är alltså inte teak som är skövlad från ömtålig regnskog. Självklart är den även FSC-certifierad. Vill en behålla finishen i teaken bör produkten slipas och oljas med teakolja för att behålla färgen. Om detta inte görs får teaken den karakteristiska grå färg som kan närmast liknas vid drivved. Här kan bara du själv avgöra vad som är snyggast! OBS! tänk på att det är viktigt att materialet är torrt vid oljning. Om Teaken inte kojas kan den också komma att bilda sprickor – detta ses då inte som en reklamation om produkten inte oljats!

Aintwood – Är ett plastmaterial framtaget för att efterlikna trä, men har bättre egenskaper för vårt skandinaviska klimat. Aintwood är ett nästintill underhållsfritt material som lättast hålls rent med vatten och såpa. Var noga med att torka bort eventuella fläckar då de annars kan tränga in i plasten och vara svåra att få bort. Bubblor i plasten kan uppkomma om materialet är utsatt för hög värme, var därför försiktig med att lämna glasartiklar på bordet i direkt solljus då dessa kan "bränna" hål i ytan på materialet. Då plast är ett poröst material kan det komma att röra sig vid temperaturväxlingar.

Polyester – Detta material används i alla våra dynor och parasoll. Detta ska ej maskintvättas utan handtvätt är rekommenderat. Då polyester kan blekas vid direkt solljus så rekommenderar vi att alltid förvara dynorna/parasollen i t.ex. dynbox / Under parasollskydd eller på annat skyddat sätt när de inte används. Detta för att förlänga hållbarheten och undvika missfärgningar.

För mer utförliga skötselråd – surfa in på www.venturehome.se och klicka dig vidare till "skötselråd"

Vi hoppas du får många sköna sommar-stunder i din nya möbel!



Hallo!

Herzlichen Glückwunsch zu Ihren neuen Gartenmöbeln.

Auf dieser Seite finden Sie einige Tipps und Tricks, um Ihre Möbel optimal zu pflegen.

Stahl - Der Rahmen Ihrer Möbel besteht entweder aus Aluminium oder Stahl. Stahl ist etwas schwerer, aber auch ein härteres Material als Aluminium und kann daher Konstruktionen standhalten, mit denen Aluminium nicht umgehen kann. Möbel mit Stahl im Rahmen können rosten, insbesondere in Küstengebieten, in denen das Salzwasser den Rost beschleunigt. Es ist daher wichtig, vorsichtig zu sein, auf welcher Oberfläche sich Ihre Möbel befinden, um Verfärbungen zu vermeiden.

Aluminium - Aluminium ist ein leichteres Material als Stahl und macht Ihre Möbel leicht und flexibel. Dieses Material sollte auch nicht rosten. Einige Teile Ihrer Möbel bestehen jedoch möglicherweise noch aus Stahl (z. B. Schrauben oder Beschläge).

Künstliches Rattan - Dieses Material ist ein Kunststoff, der bei Wetter und Wind sehr haltbar und in vielerlei Hinsicht sehr wartungsfrei ist. Wenn Sie Ihre künstlichen Rattanmöbel waschen müssen, ist dies am einfachsten mit Wasser und Seife.

Teak - Unsere Teakholzmöbel werden aus kultiviertem Teakholz hergestellt. Dh Teakholz, das angebaut wird, um Möbel oder etwas anderes zu werden, ist kein Teakholz, das aus dem empfindlichen Regenwald entfernt wird. Natürlich ist es auch FSC-zertifiziert. Wenn Sie das Finish behalten möchten Im Teakholz sollte das Produkt geschliffen und mit Teaköl geölt werden, um die Farbe zu erhalten. Wenn dies nicht getan wird, erhält das Teakholz die charakteristische graue Farbe, die fast mit Treibholz verglichen werden kann. Hier können nur Sie selbst entscheiden, was am besten aussieht! **HINWEIS!** Denken Sie daran, dass es wichtig ist, dass das Material beim Ölen trocken ist. Wenn der Teaken nicht hütet, kann er auch Risse bilden - dies wird nicht als Beschwerde angesehen, wenn das Produkt nicht geölt wurde!

Aintwood - Ist ein Kunststoff, der entwickelt wurde, um Holz nachzuahmen, aber bessere Eigenschaften für unser skandinavisches Klima hat. Aintwood ist ein nahezu wartungsfreies Material, das am einfachsten mit Wasser und Seife sauber gehalten werden kann. Wischen Sie alle Flecken ab, da sie sonst in den Kunststoff eindringen und schwer zu entfernen sind. Blasen im Kunststoff können auftreten, wenn das Material starker Hitze ausgesetzt ist. Lassen Sie Glaswaren daher nicht in direktem Sonnenlicht auf dem Tisch, da diese Löcher in der Materialoberfläche "verbrennen" können. Da Kunststoff ein poröses Material ist, kann er sich bei Temperaturänderungen bewegen.

Polyester - Dieses Material wird in allen unseren Kissen und Sonnenschirmen verwendet. Dies sollte nicht in der Maschine gewaschen werden, aber Handwäsche wird empfohlen. Da Polyester in direktem Sonnenlicht gebleicht werden kann, empfehlen wir, die Kissen / Sonnenschirme immer in z. Dynbox / Unter Sonnenschirmschutz oder auf andere geschützte Weise bei Nichtgebrauch. Dies soll die Haltbarkeit verlängern und Verfärbungen vermeiden.

Wir hoffen, Sie haben viele schöne Sommermomente in Ihren neuen Möbeln!



Hello!

Congratulations on your new outdoor furniture.

On this page you will find some tips and tricks to take care of your furniture in the best way.

Steel - The frame of your furniture is either in aluminum or steel. Steel is a little heavier but is also a harder material than aluminum and therefore can withstand constructions that aluminum cannot handle. Furniture with steel in the frame can rust, especially if they are in coastal areas where the salt water helps to speed up the rust. It is therefore important to be careful about what surface your furniture is on to avoid discoloration.

Aluminum - Aluminum is a lighter material than steel and makes your furniture light and flexible, this material should not rust either. However, some parts of your furniture may still be made of steel (for example screws or fittings)

Artificial rattan (Wicker) - This material is a plastic that is very durable when it comes to weather and wind and is in many ways very maintenance-free. If you need to wash your artificial rattan furniture, the easiest way to do this is with water and soap.

Teak - Our teak furniture is produced from cultivated teak. Teak that is grown for the purpose of becoming furniture or something else, so it is not teak that is removed from fragile rainforest. Of course, it is also FSC-certified. If you want to keep the finish in the teak, the product should be sanded and oiled with teak oil to keep the color. If this is not done, the teak gets the characteristic gray color that can almost be compared to driftwood. Here only you can decide for yourself what looks best! **NOTE!** keep in mind that it is important that the material is dry when oiling. If the Teaken is not huddled, it can also form cracks - this is not seen as a complaint if the product has not been oiled!





Aintwood - Is a plastic material developed to mimic wood, but has better properties for our Scandinavian climate. Aintwood is an almost maintenance-free material that is most easily kept clean with soap and water. Be sure to wipe off any stains as they may otherwise penetrate the plastic and be difficult to remove. Bubbles in the plastic can occur if the material is exposed to high heat, so be careful not to leave glassware on the table in direct sunlight as these can "burn" holes in the surface of the material. As plastic is a porous material, it can move during temperature changes.



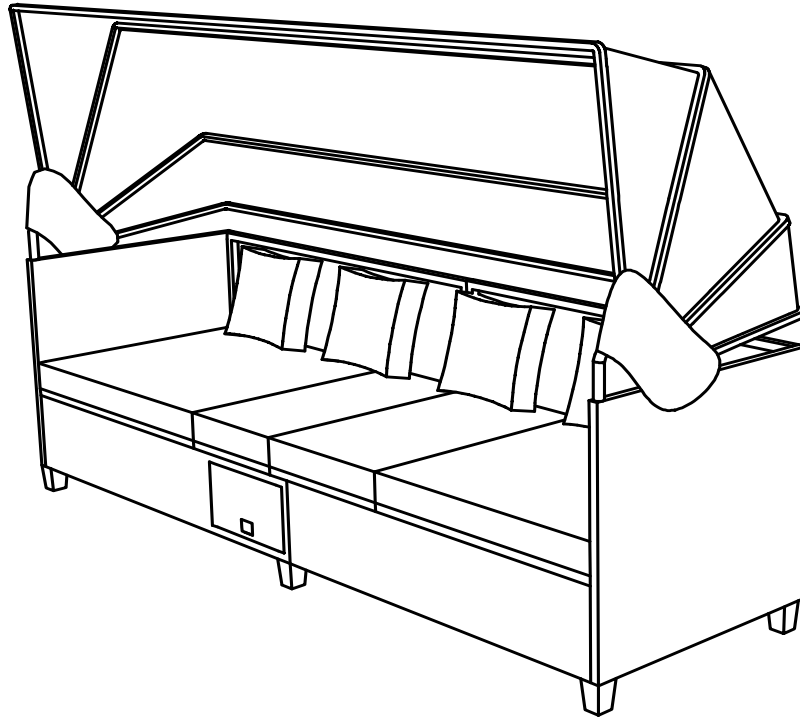

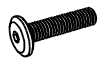

Polyester - This material is used in all our cushions and parasols. This should not be machine washed but hand washing is recommended. As polyester can be bleached in direct sunlight, we recommend always storing the cushions / parasol in e.g. dynbox / Under parasol protection or in another protected way when not in use. This is to extend the durability and avoid discoloration.

For more care-advice for your new product, go to www.venturehome.se and find "Care advise".





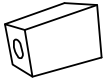





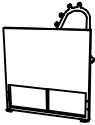
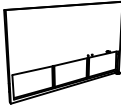
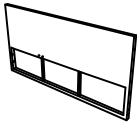
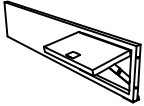



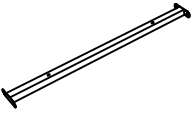
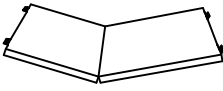
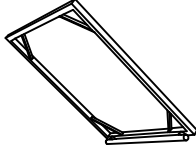
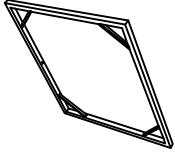
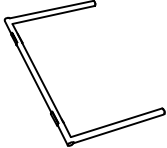

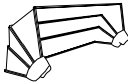

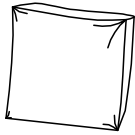

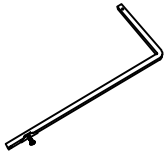
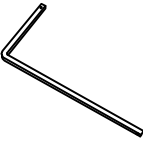

We hope you have many wonderful summer moments in your new furniture!

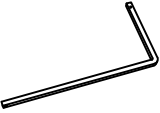

No.	Description	Qty
1	 M6x40 mm	26
2	 M6x25 mm	8
3	 M6x20 mm	14
4	 Ø6x16x3 mm	4
5	 Ø6x16x5 mm	8

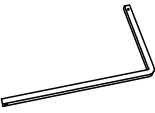
No.	Description	Qty
6	 Ø6x14x1 mm	33
7	 Eru M6	8
8	 M4x12 mm	12
9	 M6x55 mm	6
10	 6	6
11	 Allen key 4x60	1

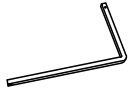

<p>A</p>  <p>(1pc)</p>	<p>B</p>  <p>(1pc)</p>	<p>C</p>  <p>(1pc)</p>	<p>D</p>  <p>(1pc)</p>	
<p>E</p>  <p>(1pc)</p>	<p>F</p>  <p>(1pc)</p>	<p>G</p>  <p>(2pcs)</p>	<p>H</p>  <p>(2pcs)</p>	
<p>I</p>  <p>(2pcs)</p>	<p>K</p>  <p>(1pc)</p>	<p>L</p>  <p>(1pc)</p>	<p>M</p>  <p>(1pc)</p>	
<p>N</p>  <p>(1pc)</p>	<p>Q</p>  <p>(1pc)</p>	<p>R</p>  <p>(1pc)</p>	<p>O</p>  <p>(1pc)</p>	
<p>P</p>  <p>(4pcs)</p>	<p>A1</p>  <p>(1pc)</p>	<p>A2</p>  <p>(1pc)</p>	<p>A3</p>  <p>(1pc)</p>	
<p>A4</p>  <p>(1pc)</p>	<p>B1</p>  <p>(1pc)</p>	<p>B2</p>  <p>(1pc)</p>	<p>B3</p>  <p>(1pc)</p>	
<p>B4</p>  <p>(1pc)</p>	<p>C1</p>  <p>(1pc)</p>	<p>C2</p>  <p>(1pc)</p>	<p>C3</p>  <p>(1pc)</p>	
<p>C4</p>  <p>(1pc)</p>	<p>D1</p>  <p>(1pc)</p>	<p>D2</p>  <p>(1pc)</p>	<p>D3</p>  <p>(1pc)</p>	<p>D4</p>  <p>(1pc)</p>

Step 1:

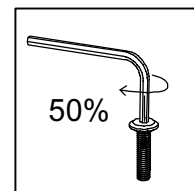
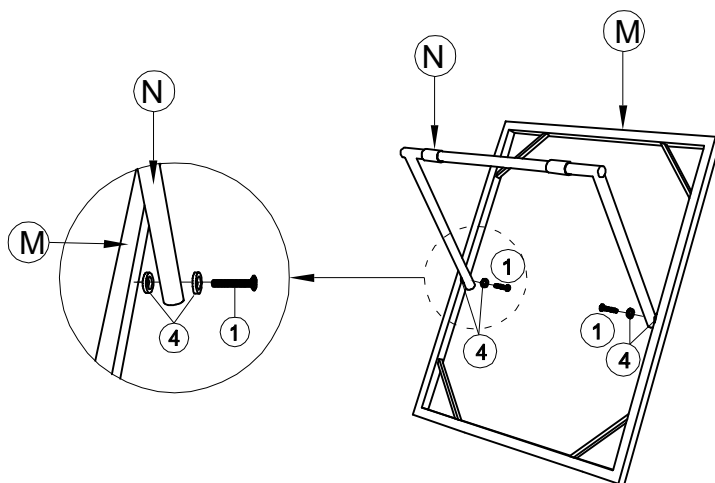

- ① *2
- ④ *4
- M*1
- N*1

Step 2:

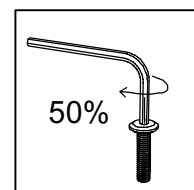
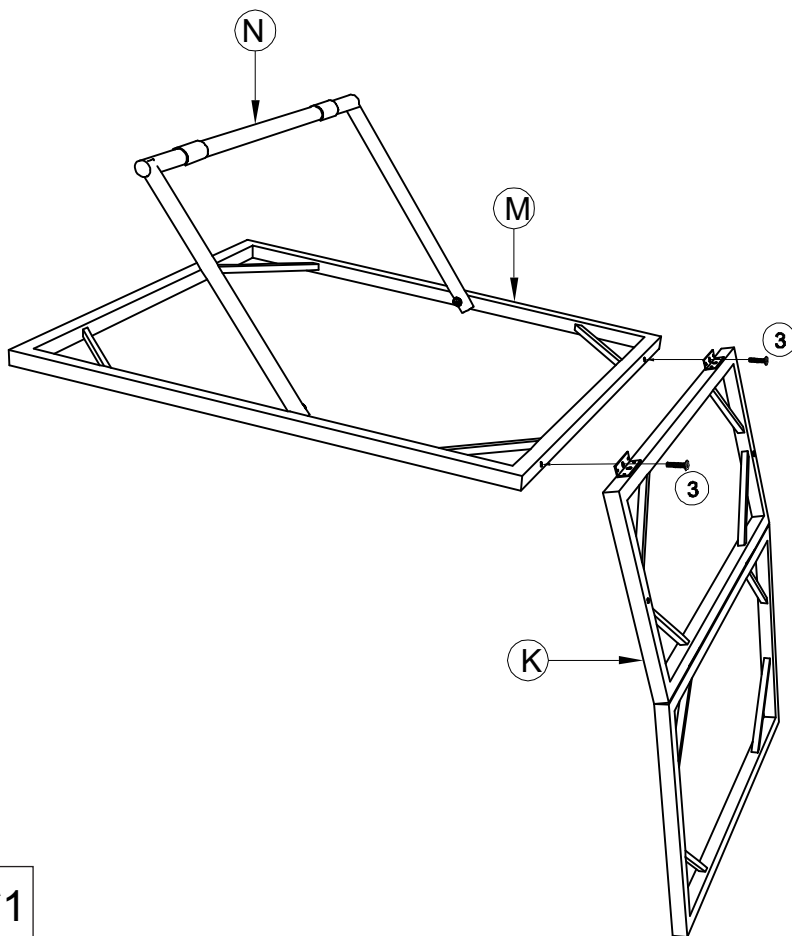

- ③ *2
- K*1
- M*1

Step 3:

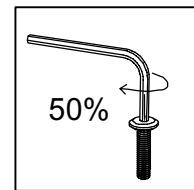
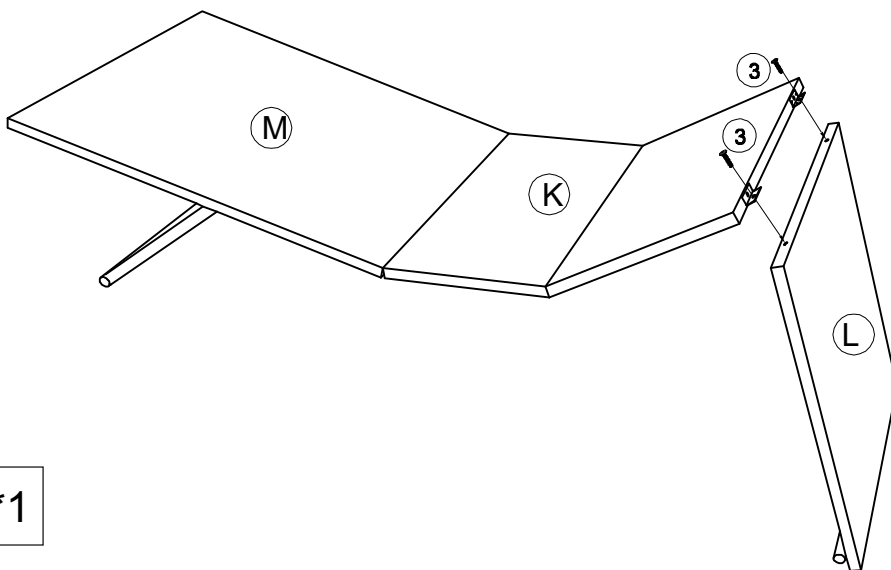
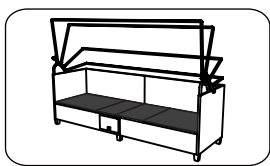

③ *2 K*1 L*1

Step 4:

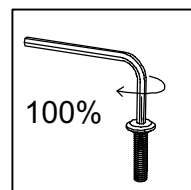
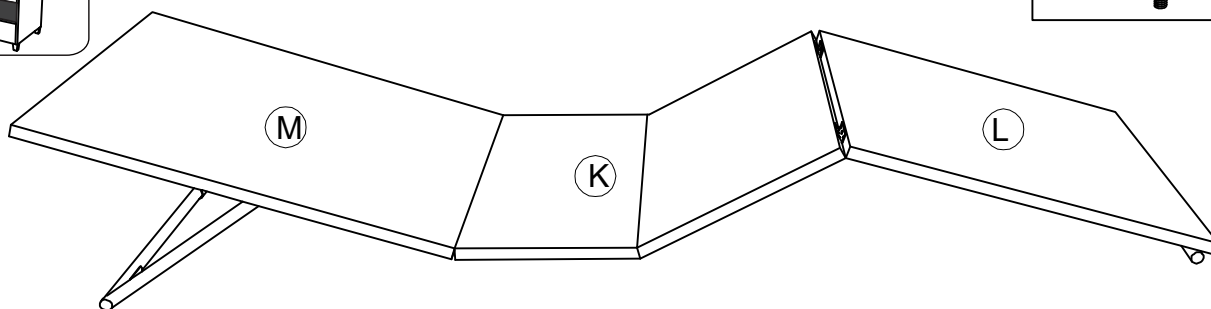

Step 5:

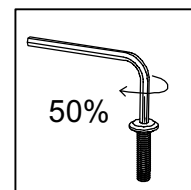
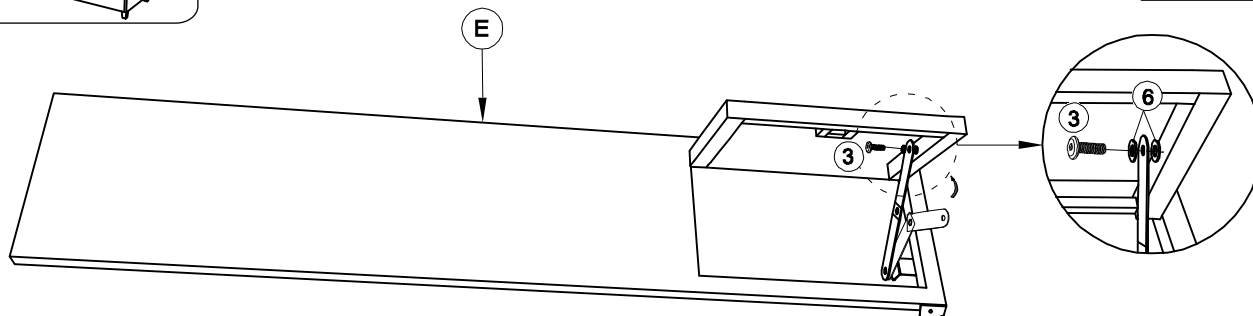
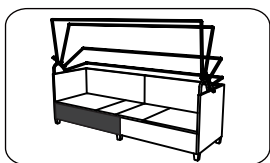

③ *1 ⑥ *2



@Venturehomese
@Venture.Design

Do not tighten screws until all screws have been assembled!

Step 6:

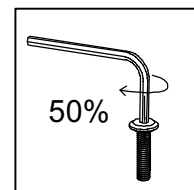
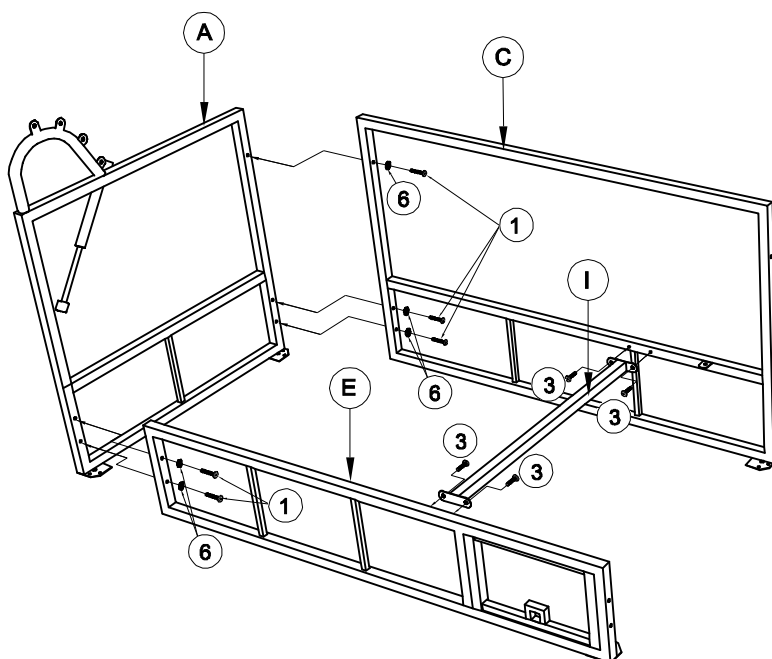
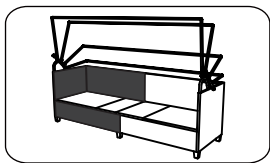

- ①*5
- ③*4
- ⑥*5
- A*1
- C*1
- E*1
- I*1

Step 7:

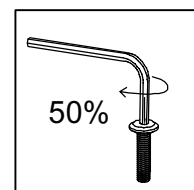
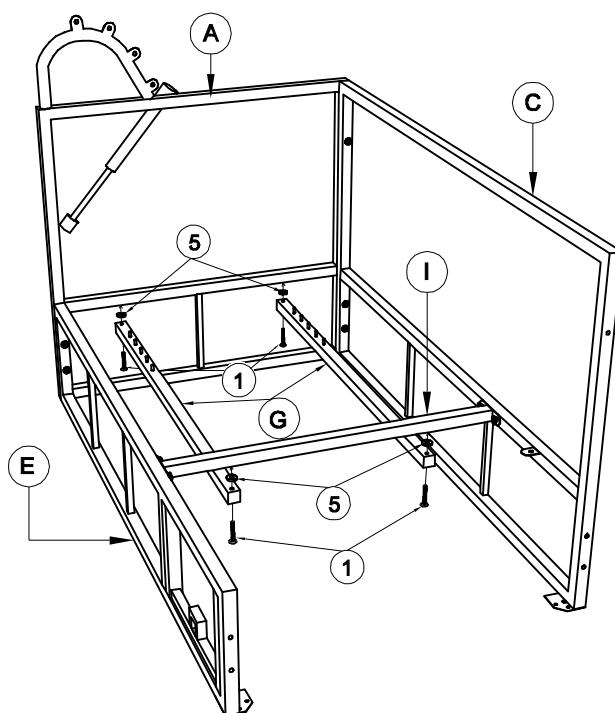
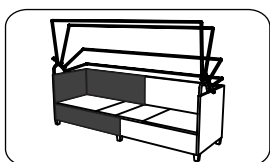

- ①*4
- ⑤*4
- A*1
- G*2
- I*1

Step 8:

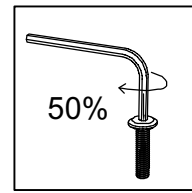
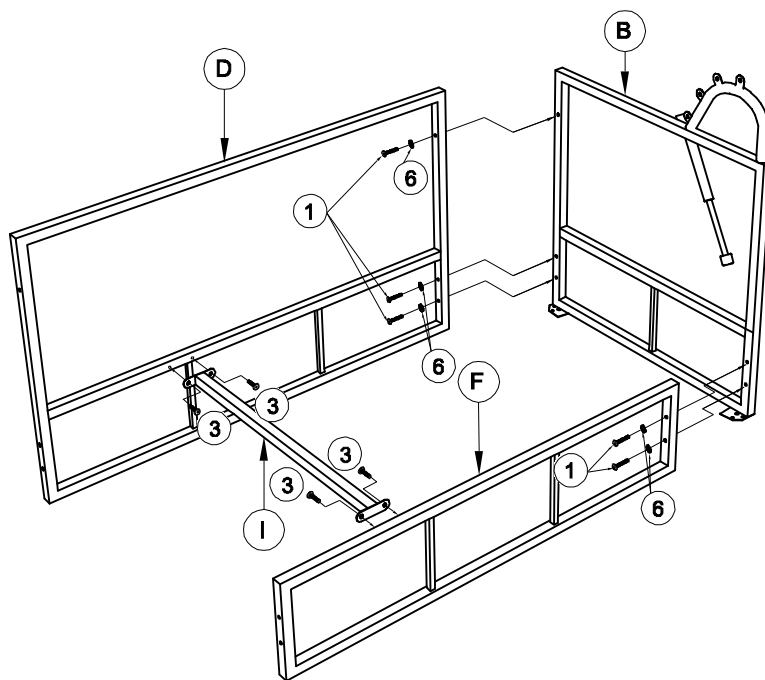
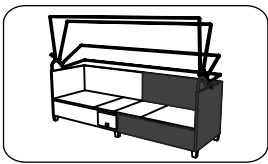

- ① *5
- ③ *4
- ⑥ *5
- B *1
- D *1
- F *1
- I *1

Step 9:

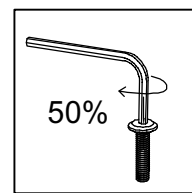
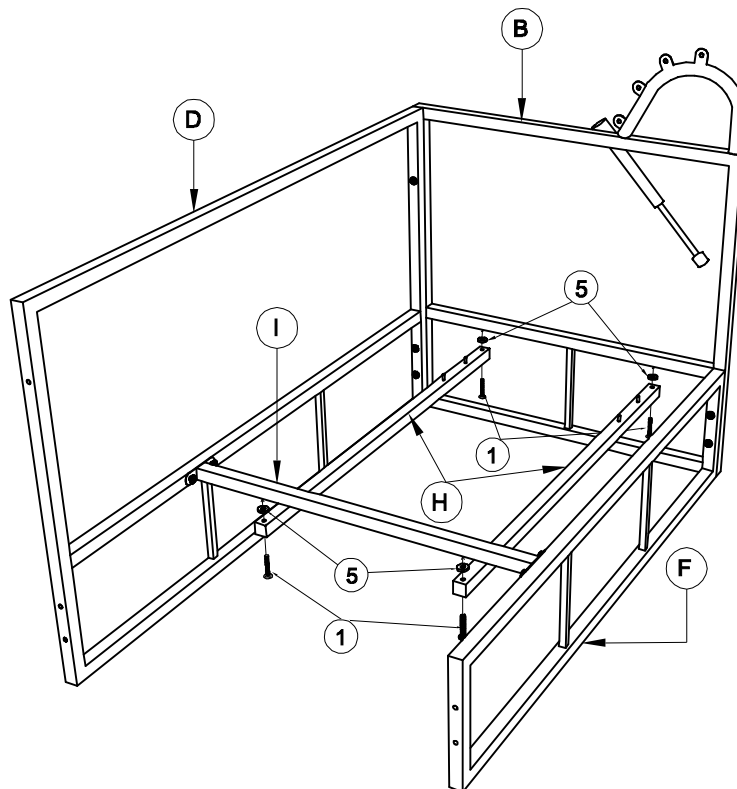
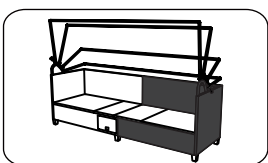

- ① *4
- ⑤ *4
- B *1
- H *2
- I *1

Step 10:

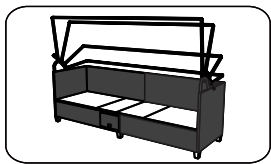

- ① *2
- ⑥ *2
- C*1
- D*1
- Q*1

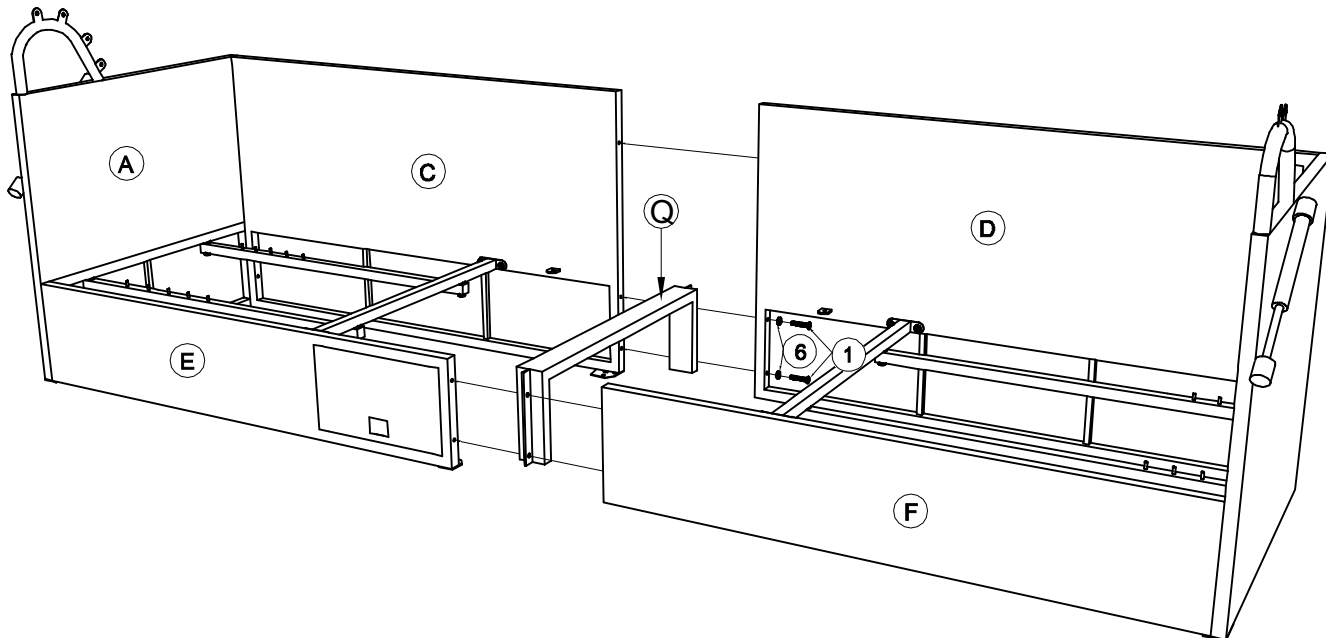
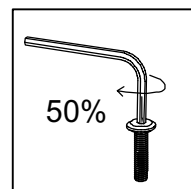

Step 11:



- ① *3
- ⑥ *3
- C*1
- D*1
- E*1
- F*1
- Q*1

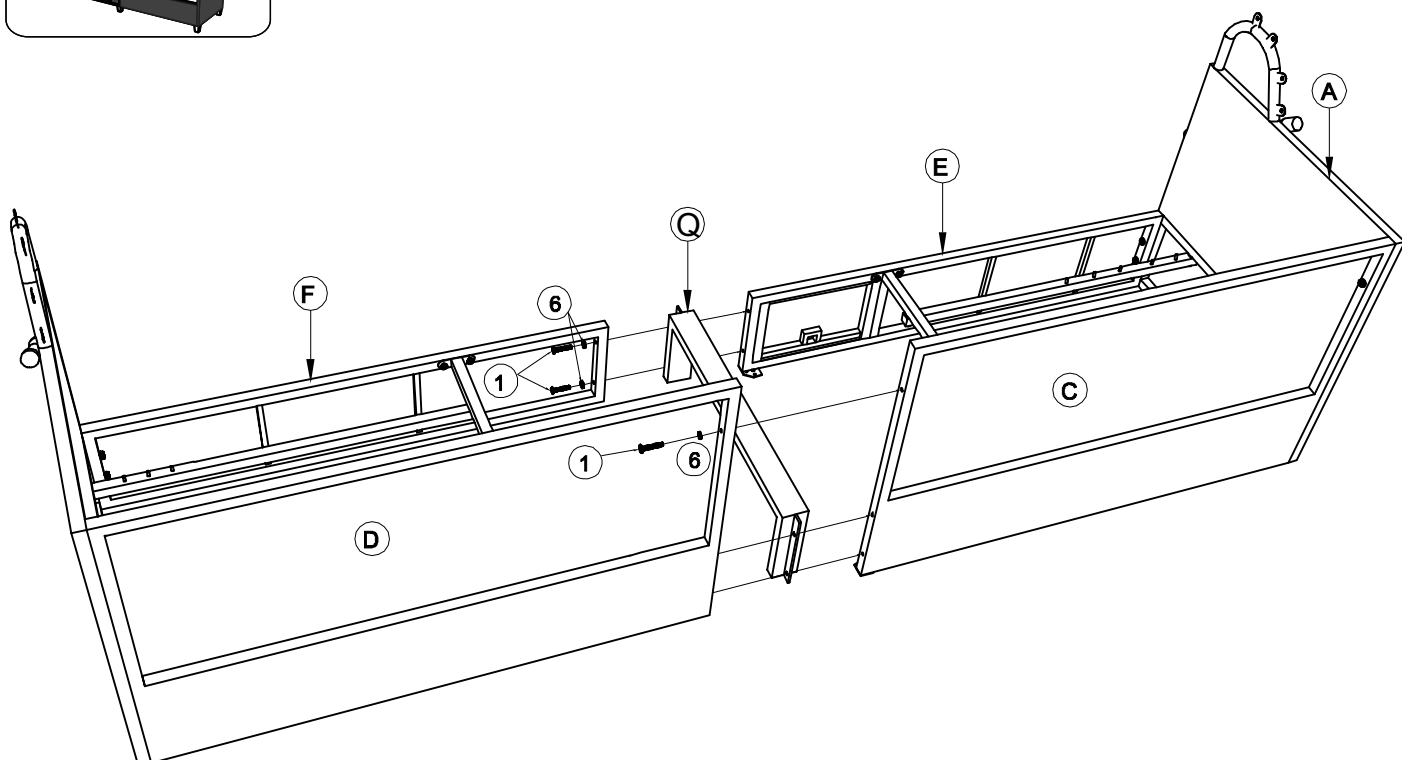
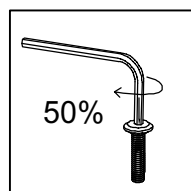

Step 12:



⑨ *6 ⑩ *6

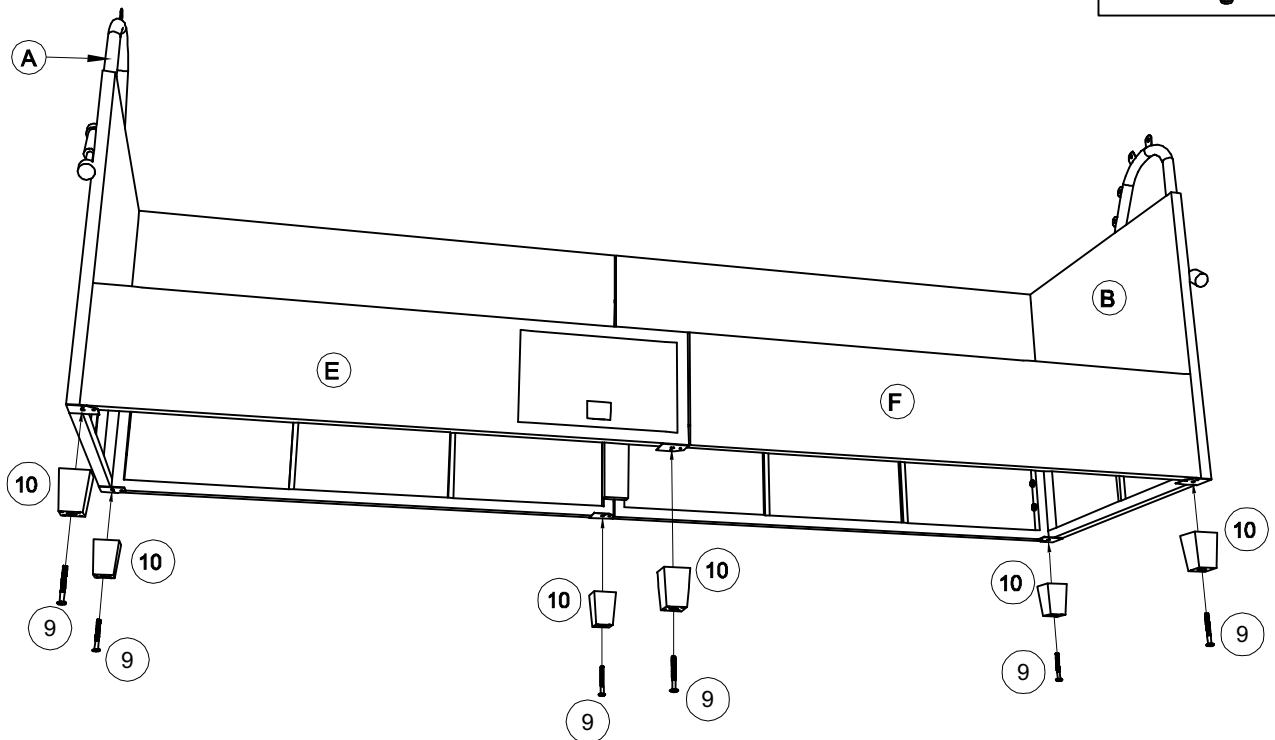
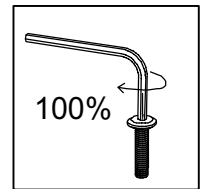

Step 13:

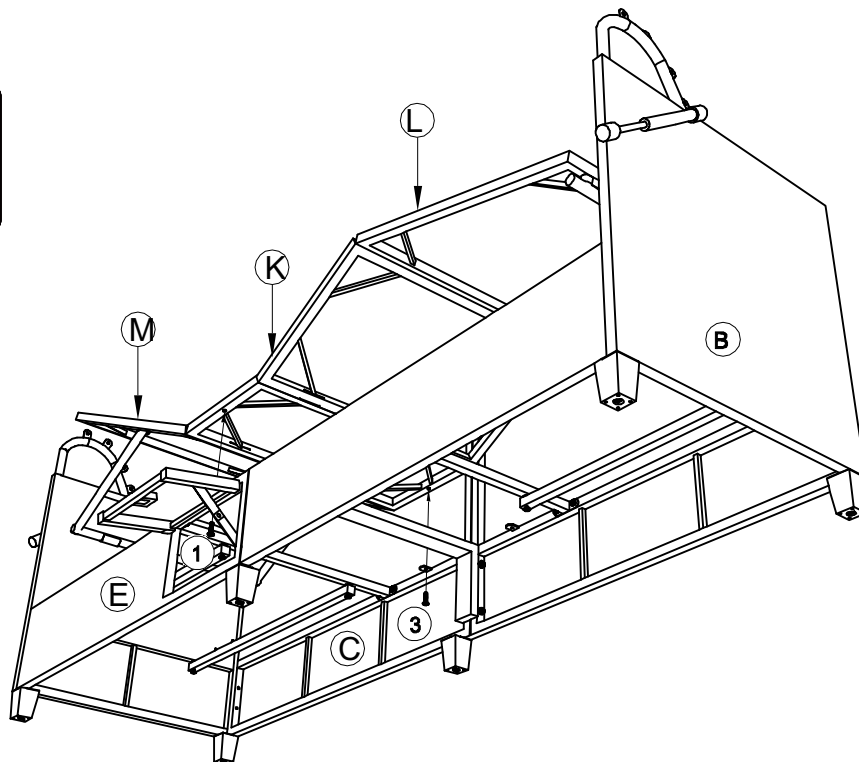
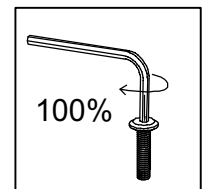
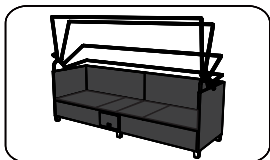

① *1 ③ *1 C*1 E*1 K*1

Step 14:

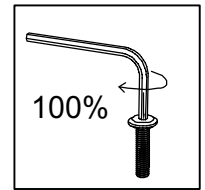
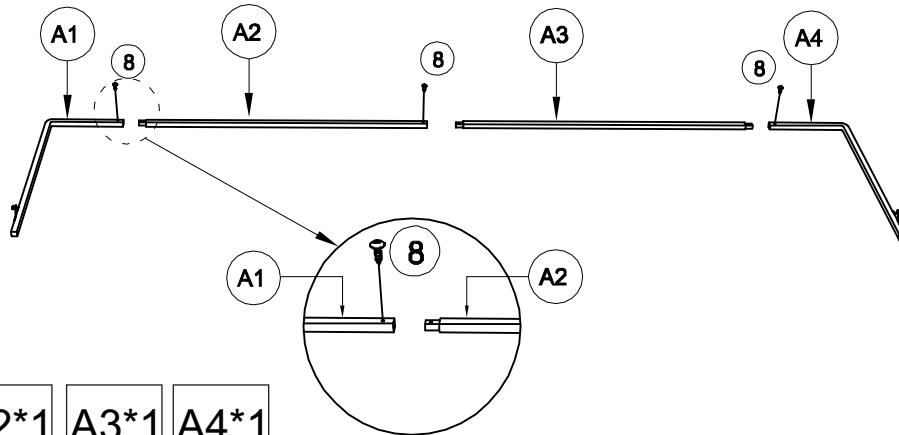
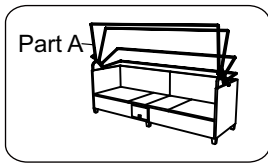

- (8) *3
- A1*1
- A2*1
- A3*1
- A4*1

Step 15:

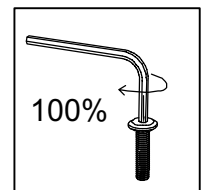
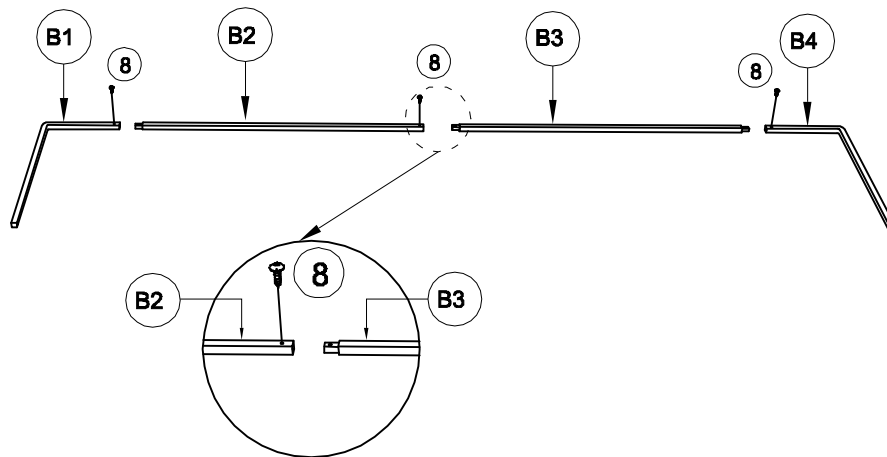
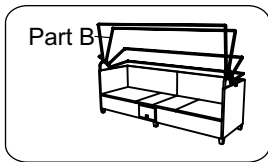

- (8) *3
- B1*1
- B2*1
- B3*1
- B4*1

Step 16:

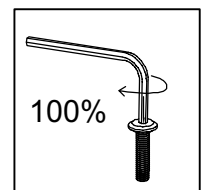
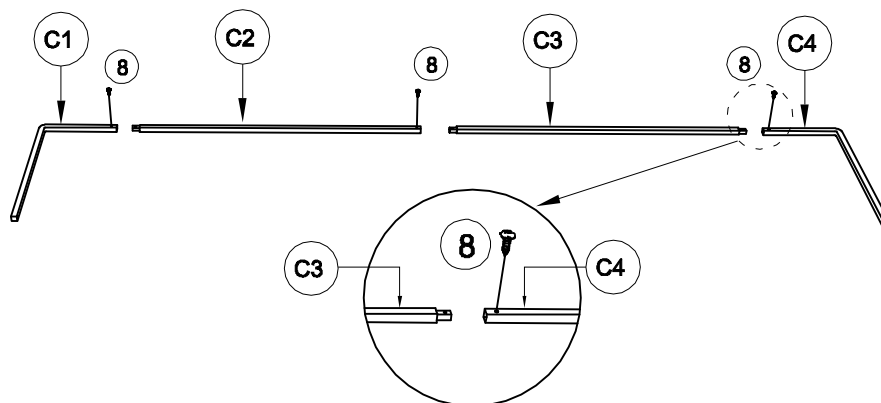
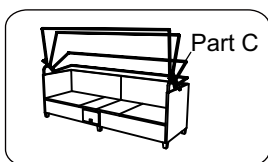

- (8) *3
- C1*1
- C2*1
- C3*1
- C4*1

Step 17:

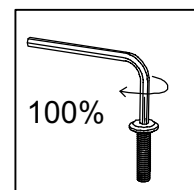
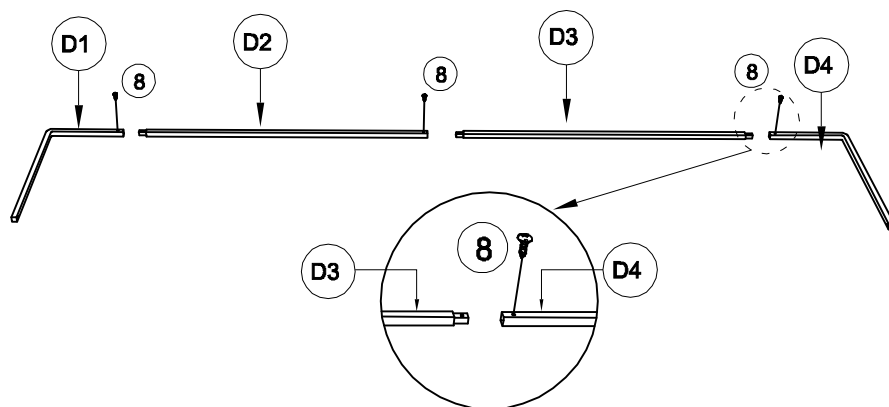
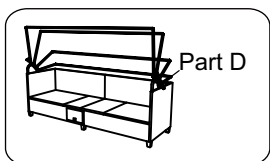

- (8) *3
- D1*1
- D2*1
- D3*1
- D4*1

Step 18:

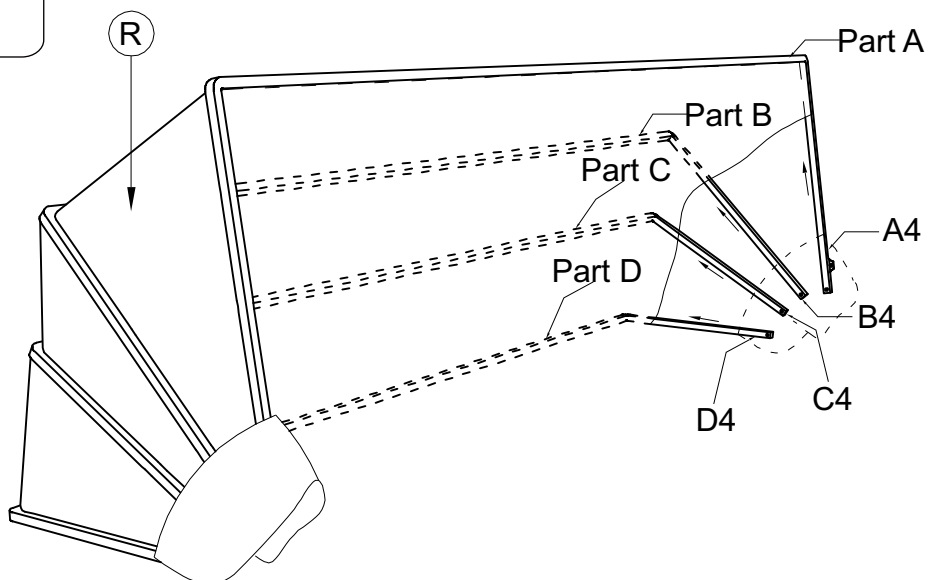

- R*1
- Part A*1
- Part B*1
- Part C*1
- Part D*1



@Venturehomese
@Venture.Design

Do not tighten screws until all screws have been assembled!

Step 19:

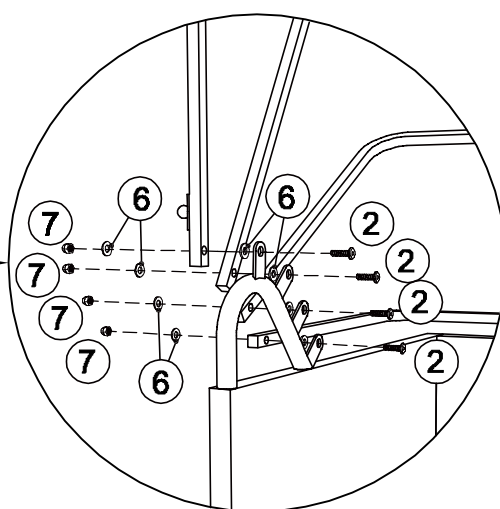
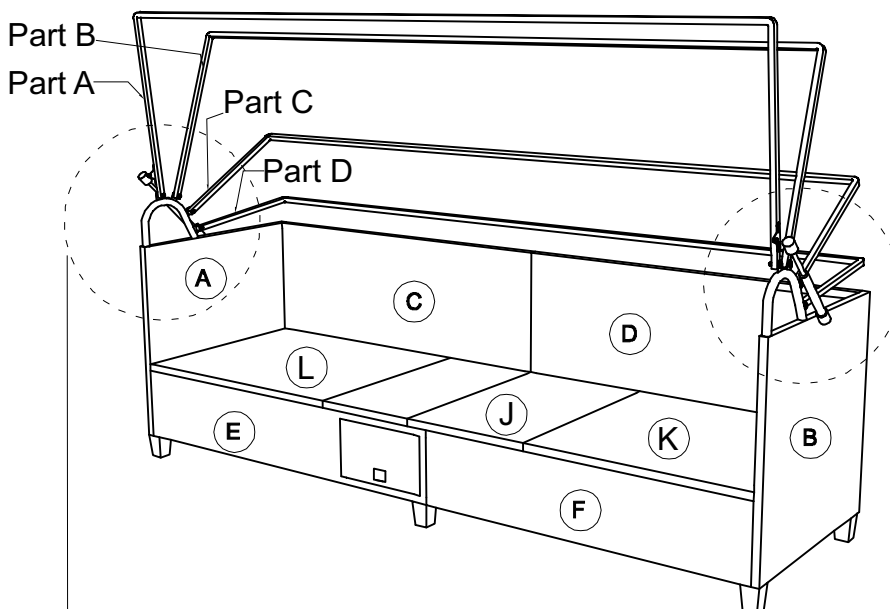
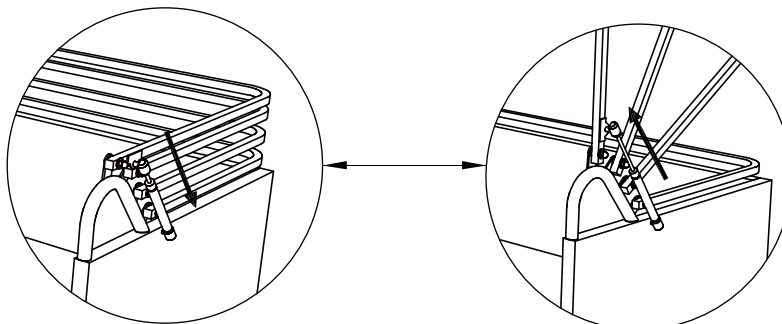
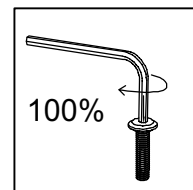

- | | | | | | | | | |
|------|-------|------|-----|-----|----------|----------|----------|----------|
| ② *8 | ⑥ *16 | ⑦ *8 | A*1 | B*1 | Part A*1 | Part B*1 | Part C*1 | Part D*1 |
|------|-------|------|-----|-----|----------|----------|----------|----------|

Step 20:

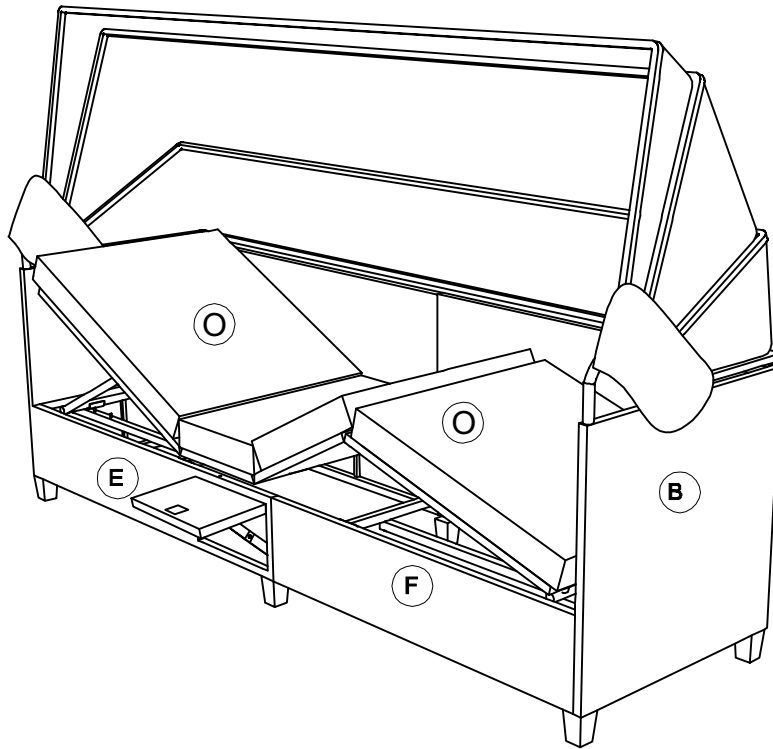
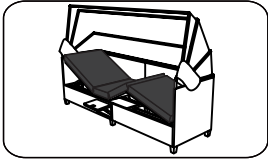

Step 21:

