



DESIGNLIGHT

SCANDINAVIAN AB

STRÅLKASTARE, ELLY

E-NR: 77 701 94

ART NR: EB-50

EFFEKT POWER	MATERIAL	KELVIN	ARMATURFÄRG ARMATURE COLOR	ANSLUTNING CONNECTION	TOTAL LUMEN	USEFUL LUMEN
50W	ALUMINIUM	4000K	GRA/GREY	230V	7548LM	8500LM

CE, RoHS



LIFETIME
L80B50: 82.000H



- EFFEKTIVITET UPP TILL 160~170 LUMEN/WATT
- DRIVDON TÄND/SLÄCK, 0-10V
- 6JUTET ALUMINIUMHUS MED AKZO NOBEL PULVERLACK

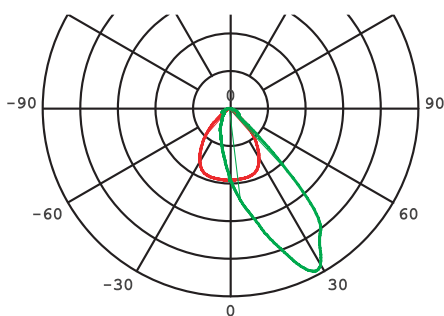

ANTAL ARMATURER PER SÄKRING

B10	B16	C10	C16	D10	D16
3	5	5	8	11	17

ÖVERSPÄNNINGSSKYDD
CM: 6KV, DM: 4KV

Mått/Dimension

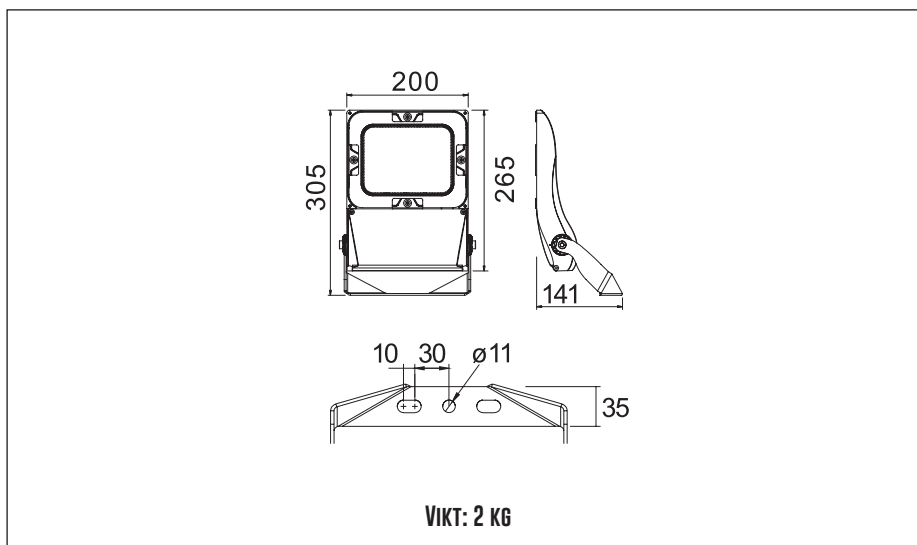

SÄKERHET:

- 1 Installation och underhåll ska utföras av behörig installatör.
- 2 Den externa kabeln/sladden på denna armatur kan inte bytas ut. Om sladden är skadad måste armaturen kasseras.
- 3 Jord ska vara väl ansluten.
- 4 Se till att armaturen är kopplad med rätt märkspänning.
- 5 Använd inte kemiska eller frätande medel för att rengöra armaturen.
- 6 Minsta avstånd mellan armatur och upplyst objekt ska vara minst 0,3 meter.

SAFETY:

- 1 Installation and maintenance must be performed by qualified person.
- 2 The external flexible cable or cord of the luminaire cannot be replaced. If the cord is damaged, the luminaire shall be destroyed.
- 3 Ground wire must be well connected.
- 4 Please make sure the lamp is working with correct input voltage.
- 5 Do not use chemicals or corrosive cleaner to clean the fixture.
- 6 The minimum distance from lighted objects to luminaires shall be kept at least 0.3 m.



1.900K	2.700-3.000K	4.000-4.500K	4.800K	5.000-5.000K	7.000-7.500K	10.000K
STEARINLJUS CANDLE	VARMVIT WARM WHITE	NATURLIG VIT NATURAL WHITE	SOLLJUS DIRECT SUN	VITT DAGSLJUS DAY WHITE	KALLVIT COOL WHITE	BLÅ HIMMEL BLUE SKY

LÄS MER OM VÅRA GARANTIVILLKOR PÅ WWW.DESIGNLIGHT.NU

DESIGNLIGHT
SCANDINAVIAN AB

DESIGNLIGHT SCANDINAVIAN AB · TOFFELVÄGEN 1 · 342 60 MOHEDA

KUNDCENTER: TELEFON 0472-716 10 · FAX 0472-716 09 · INFO@DESIGNLIGHT.NU · WWW.DESIGNLIGHT.NU