

# KÄRCHER

## WV 5 Premium

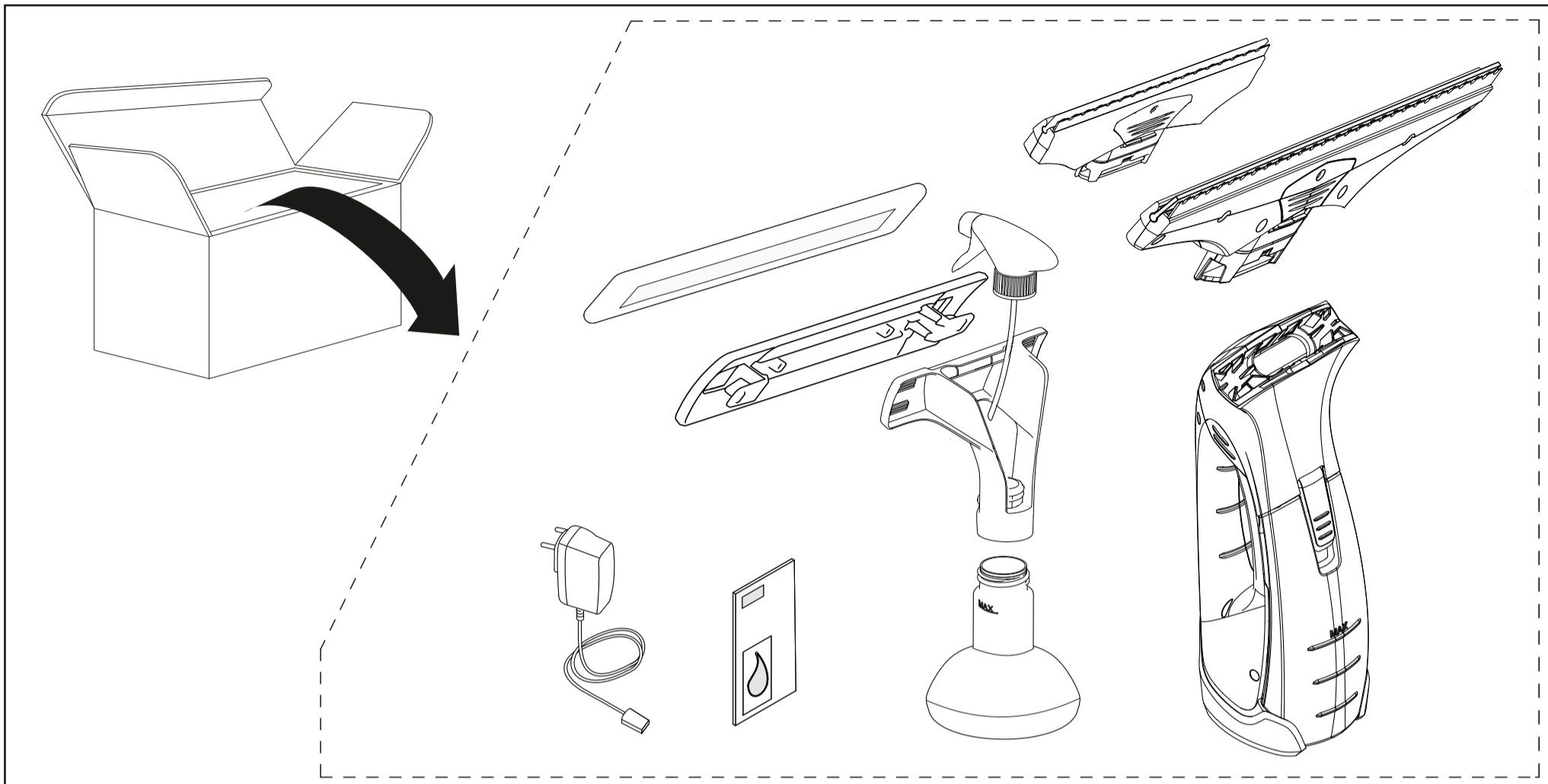

	3,7 V		IPX4		0,7 kg
	10 W		100 ml		185 min
	V 5,5 mA 600		50 db(A)		35 min

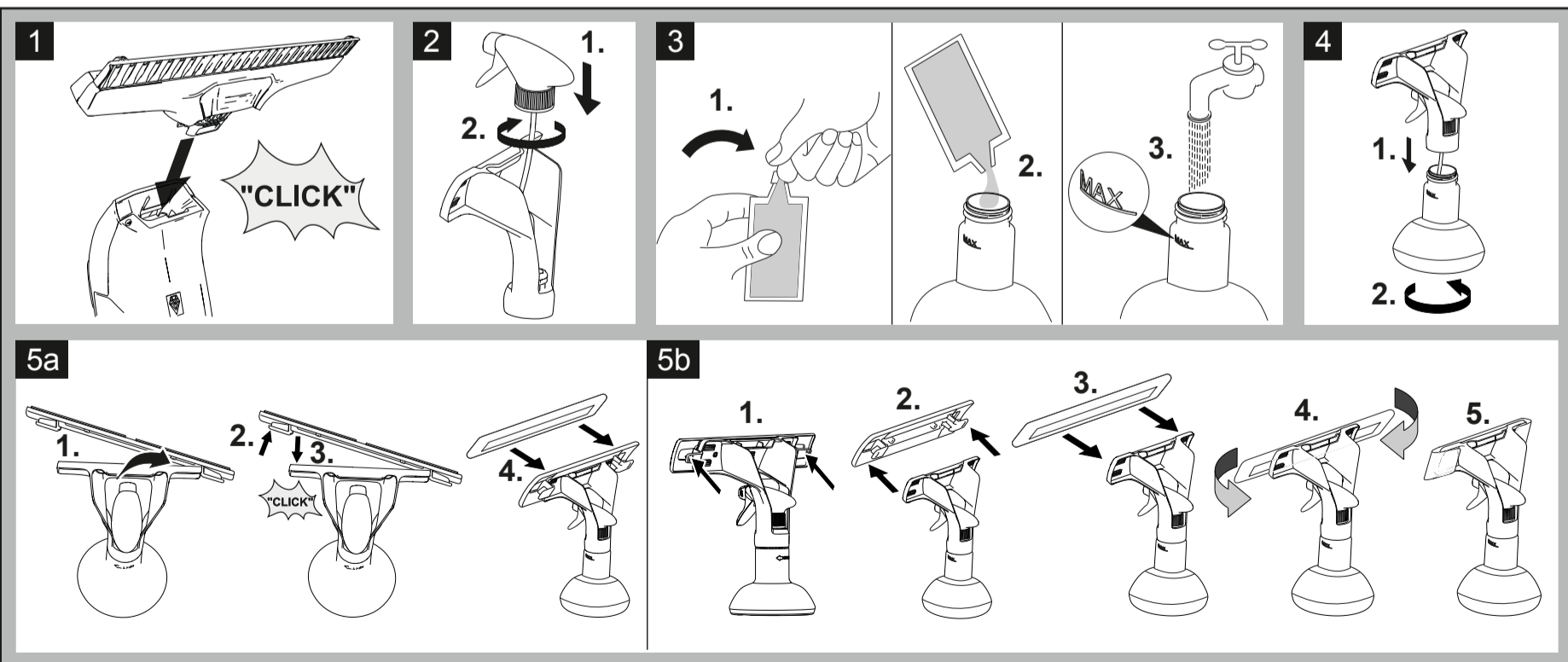
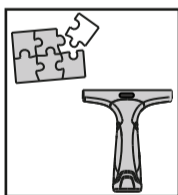

EAC

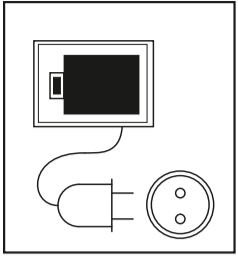

**1**

**2**

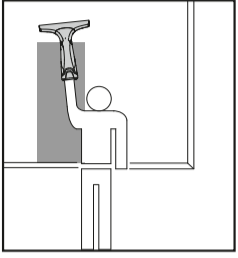

**1**

**2**

**3**

**4.1**

**4.2**

**4.3**

**4.4**

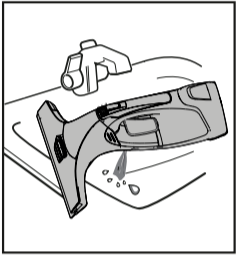

**1**

**2**

**3**



**1**

**2**

**3**

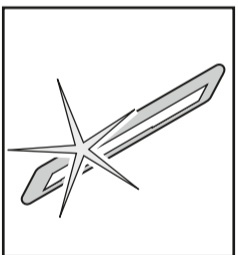

**1**

**2**

**3**

**4**

**5**

**6**

**7**

**8**

**9**

**10**

**11**

**12**

**13**

**14**

**15**

**16**

**17**

**18**

**19**

**20**

**21**

**22**

**23**

**24**

**25**

**26**

**27**

**28**

**29**

**30**

**31**

**32**

**33**

**34**

**35**

**36**

**37**

**38**

**39**

**40**

**41**

**42**

**43**

**44**

**45**

**46**

**47**

**48**

**49**

**50**

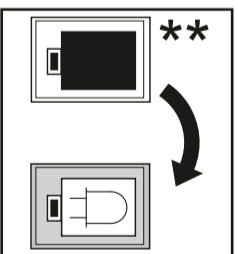

**1**

**2**

